



NH Dual Indicator System Catalogue



Cooper Bussmann, a division of Cooper Industries, is the leading source of circuit protection solutions in the global marketplace. Cooper Bussmann products are approved for use around the world and meet agency requirements and international standards: IEC, VDE, DIN, UL, CSA, BS and others.

Cooper Bussmann global headquarters are in St Louis, Missouri (US) and the European headquarters are in Burton-on-the-Wolds, Leicestershire (UK).

Cooper Bussmann manufacture over 50,000 part numbers covering extensive circuit protection solutions for a wide range of applications: residential, industrial, motor protection, power conversion, distribution, telecommunications, electronics and automotive.

Cooper Bussmann has been a leading exponent in the design, development and manufacture of low voltage fuse links and their associated accessories for more than 90 years and has supplied fuse links to more than 90 countries worldwide.

The Cooper Bussmann team of specialist engineers plays a leading role in international standardisation of low voltage fuse links, offering comprehensive advice on selection and applications.

With a continual commitment to meet our customers' needs with innovative high quality products with ISO 9002 "approval systems", Cooper Bussmann is the suppliers' choice for low voltage circuit protection solutions, today.

Table of contents

NH Fuse Links Application	4 to 7
NH Fuse Links Sizing Guide and Dimensions	8 - 9
Product Range and Ordering Key	10
NH 400 Volts gG/gL - Specifications	11
NH 400 Volts gG/gL - Part Numbers	12
NH 400 Volts gG/gL - Size 000	13
NH 400 Volts gG/gL - Size 00	14
NH 400 Volts gG/gL - Size 01 & 1	15
NH 400 Volts gG/gL - Size 02 & 2	16
NH 400 Volts gG/gL - Size 03 & 3	17
NH 400 Volts gG/gL - Cut-Off Characteristics	18
NH 500 Volts gG/gL - Specifications	19
NH 500 Volts gG/gL - Part Numbers	20
NH 500 Volts gG/gL - Size 000	21
NH 500 Volts gG/gL - Size 00	22
NH 500 Volts gG/gL - Size 0	23
NH 500 Volts gG/gL - Size 01 & 1	24
NH 500 Volts gG/gL - Size 02 & 2	25
NH 500 Volts gG/gL - Size 03 & 3	26
NH 500 Volts gG/gL - Size 4	27
NH 500 Volts gG/gL - Cut-Off Characteristics	28
NH 690 Volts gG/gL - Specifications	29
NH 690 Volts gG/gL - Part Numbers	30
NH 690 Volts gG/gL - Sizes 000 & 00	31
NH 690 Volts gG/gL - Size 0	32
NH 690 Volts gG/gL - Size 1	33
NH 690 Volts gG/gL - Size 2	34
NH 690 Volts gG/gL - Size 3	35
NH 690 Volts gG/gL - Cut-Off Characteristics	36
NH 500 & 690 Volts aM - Specifications	37
NH 500 & 690 Volts aM - Part Numbers	38
NH 500 & 690 Volts aM - Time-Current Characteristics	39
NH 500 & 690 Volts aM - Cut-Off Current Characteristics	40
NH 500 & 690 Volts aM - Technical Data	41
NH Fuse Base - Specifications	42
NH Fuse Base - Technical Data	43
NH Fuse Base - Dimensions	43 - 44
NH Fuse Rails - Specifications	45
NH Fuse Rails - Dimensions	46
NH Fuse Switch Disconnectors Vertical - Specifications	47
NH Fuse Switch Disconnectors Vertical - Technical Data	48
NH Fuse Switch Disconnectors Vertical - Dimensions	48
NH Fuse Switch Disconnectors Horizontal - Specifications	49
NH Fuse Switch Disconnectors Horizontal - Technical Data	50
NH Fuse Switch Disconnectors Horizontal - Dimensions	51 - 53
Index	54 - 55

NH Fuse Links Application

Introduction

The Cooper Bussmann® NH fuse link range uses the latest technology to provide class leading fuse link performance and reliable indication. With a unique patented dual indicator design capable of operating a micro switch for remote fuse indication, Cooper Bussmann provides one of the most reliable solutions available. The range is fully compliant with IEC 60269 standards with VDE 0636-2 third party approval and complies with the dimensional requirements of DIN 43620 for ease of use.

In order to help select the correct product for an application, Cooper Bussmann provides the following application notes.

Selecting the Correct Product

Before making a fuse link selection the following information should be known about the system or circuit to be protected.

Type of Application (Cable Protection / Motor Protection)

For general applications or cable protection, the standard gG (general purpose) NH fuse link should be considered. For Motor protection applications, the aM (motor protection) NH fuse link should be considered. Motor Protection (aM) fuse links have partial range breaking ability and cannot clear low overload faults. They should only be applied to circuits also protected by a motor protection relay or where only high short-circuit faults could occur.

Please note that misapplication of a fuse link can be dangerous, consult Cooper Bussmann if there is any doubt over fuse link selection.

System Voltage

Cooper Bussmann NH fuse links are available in three voltage ratings, 400V, 500V and 690V. These are maximum voltage ratings and should not be used where the system voltage could exceed the fuse link's maximum rating.

Full Load Current

In accordance with IEC standards, Cooper Bussmann NH fuse links are tested to carry full load current. The rated current of a fuse link should be equal or greater than the operational current of the circuit and equal or smaller than the continuous current carrying capacity of the conductor.

The standard gG (general purpose) NH fuse link with a conventional fusing current of 1.6 times rated current will give assured cable protection against the effects of overcurrents.

Non-Fault Overload Currents (motor inrush currents etc)

To prevent nuisance operation of the fuse link, the fuse link rating selected for the application should take into account any non-fault overload currents. *Please refer to the time-current curves in the catalogue.*

Possible Fault Conditions and Maximum Short-Circuit Current

This information is essential in order to select the fuse link that would provide the best possible protection under all fault conditions. Cooper Bussmann NH fuse links have a maximum breaking capacity of 120kA and should never be used on a system where the maximum short-circuit current exceeds this level. *Please refer to the time-current curves in the catalogue.*

NH Fuse Links Application

Using Cooper Bussmann Fuse Link Curve Data

Time-Current Curves

The time-current curve is probably the most useful piece of all fuse link data available. It allows you to determine how quickly the fuse link will operate under fault conditions and which fuse link will not operate under non-fault overload currents.

To use the curve simply plot the prospective Root Mean Square (RMS) fault current along the X axis and draw a line vertically upwards from this point. Where this point intersects the fuse curve line, plot a line across to the Y axis for the relevant rating. The Y axis shows the nominal operating time for the fuse in seconds. Hence, it shows how quickly the fuse link will operate under different fault currents.

The graph can be used to check if a fuse link can withstand an overload condition that is not considered to be a fault such as a direct-on-line (DOL) motor start. For example, if a motor starts and the inrush current is six times the full load current for 10 seconds, the exact point can be plotted onto the time-current curve. Any fuse link line lying to the right of this point will withstand the motor start current (allowing for a +/-10% tolerance on each fuse link curve). If the fuse link curve falls to the left of this point, then the fuse link will not withstand the motor start current and will inadvertently operate when the motor is started.

In summary, the rule for time-current curves is that any point on or to the right of a fuse link curve would indicate the fuse link has operated in the given time. Any point to the left of the curve would indicate the fuse link has not operated.

Cut-Off Curves

The graph consists of an A-B line running diagonally from bottom left to top right, see drawing below. This is known as the none current-limiting line. Branching from this A-B line you can see each individual fuse link rating line running diagonally left to right. To read the graph, plot the RMS prospective fault current along the X axis. If this point only intersects the A-B line then the prospective fault current is too low to benefit from the current-limiting effect of the fuse link.

However, if this point intersects the relevant fuse link line, plot a line across to the Y axis. This point on the Y axis shows the peak asymmetrical let-through current the fuse link will allow to pass before operating. The peak asymmetrical let-through current is the absolute worst case peak current the fuse link will allow to pass through, taking into account the DC offset seen under short-circuit conditions and low power factor.

The RMS let-through current is read from the graph using the same procedure above. Instead of plotting the point of intersection with the fuse link current-limiting line over to the Y axis, it should only be plotted as far as the A-B line. At this point, a line can be drawn back down to the X axis to show a RMS symmetrical value of let-through current. This is known as the “up, over and down method”.

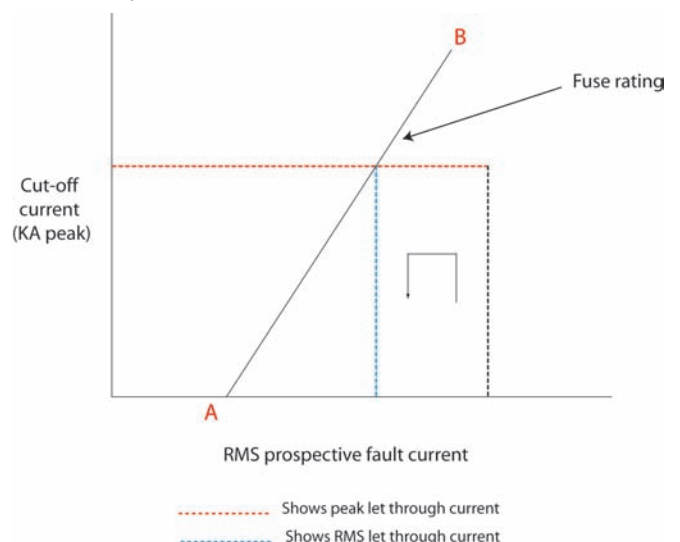

NH Fuse Links Application

I²t Values

I²t values are measured at the time of testing the fuse link at their rated breaking capacity and voltage. I²t is effectively the amount of heating energy the fuse link will allow to pass during fault clearing at high short-circuit faults. I²t values relevant for short-circuit faults cannot be calculated from the time-current or cut-off curves. The published I²t figures always show two values, **pre-arcing/total clearing** and are representative of the area under the first half cycle of the fault current.

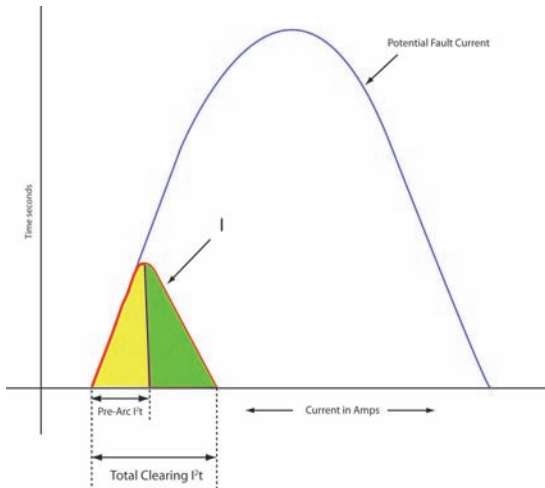

- The **pre-arcing** value is the area under the first half cycle of fault current showing on the graph in yellow to the point just before an arc occurs within the fuse link. This is due to the element material being vaporised by the very high short-circuit current.
- The **total clearing I²t** is the yellow and green area under the first half cycle from the start of the short-circuit current flow to the point where the fuse link has become an insulator, completely isolating the flow of current.

The diagram here shows a representation of I²t during a half cycle of fault current.

I²t values give a good representation of the speed of operation of a fuse link. A small I²t value would indicate a very fast-acting fuse link whereas a large I²t value would indicate a fairly slow operating fuse link. In all cases the total clearing I²t value of the fuse link must be smaller than the I²t value of the device to be protected in order for the fuse link to provide adequate protection against short-circuit faults. For fuse link discrimination (see definition of discrimination below) in distribution systems, the total clearing I²t value of the fuse link downstream should be less than the pre-arcing I²t value of the fuse link upstream. This ensures the smaller fuse link, in the system operates well before the larger upstream fuse link.

NH Discrimination

Cooper Bussmann® NH fuse links are easy to use on distribution networks where discrimination between large and small fuse links are required. This can be achieved by applying a discrimination factor of 1 to 1.6 without the need to check the fuse link data. For example, by using a 100A fuse link downstream from the main 160A fuse link, in the event of a fault condition, the smaller 100A fuse link is sure to operate before the 160A fuse link, ensuring discrimination.

DC Applications

Cooper Bussmann NH fuse links can be used on DC applications. In all cases the fuse links can be used at **half of their AC rating** with a time constant of no more than 10mS. The time constant is the rate of rise of fault current and should be as close to a 50Hz AC half cycle as possible.

Power Loss

Every effort is made to ensure the power loss of the fuse link is kept to a minimum. Cooper Bussmann provides fuse links with some of the lowest power losses in the industry. Power loss of the fuse link is given off as heat and this should be taken into account when fitting fuse links into unventilated areas. It is preferable that a fuse link has good airflow around the body of the fuse link to ensure cool running and prevent nuisance operation of the fuse link due to thermal stresses.

Should further information be required please contact Cooper Bussmann application engineers on 00 44 (0) 1509 882699

NH Dual Indicator System from Cooper Bussmann

- High breaking capacity
- 400Vac, 500Vac and 690Vac
- Dual indication
- Insulated Tag Variants
- IEC 60269-2, DIN 43620, VDE 0636-2, CE Mark



Features of NH DIN range



Dual Indicator System

Cooper Bussmann patented dual indicator provides clear indication, ensuring extremely reliable local and remote* signalling, decreasing fuse link replacement time and costs.

* with the use of an optional microswitch accessory



Low Power Loss

Cooper Bussmann NH “low watts loss” fuse links reduce overall operating costs and carbon footprint through lower energy consumption and heat transfer to equipment. To find out how much you can save, please contact our technical applications department: buletechnical@cooperindustries.com.



Globally Compliant

Cooper Bussmann NH fuse links are tested and comply with IEC 60269, DIN 43620, VDE, CE, CCC (China), RoHS and can be recycled, ensuring global acceptance.

Cd/Pb-free

Lead and Cadmium Free

Cooper Bussmann is the world’s first true manufacturer of a complete range of Lead and Cadmium free NH fuse links. Negating any legislation concerns regarding the amount of hazardous materials permissible within the fuse links.



Recycling

Cooper Bussmann is dedicated to produce recyclable products and is a member of an industry recognised recycling scheme. The “HRC” symbol on Cooper Bussmann NH fuse links define the product suitable for recycling, limiting disposal cost.

Sizing Guide

Size 000

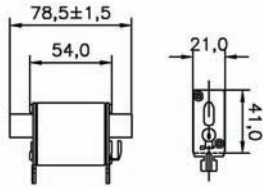

Size 00

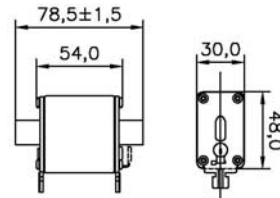

Size 0

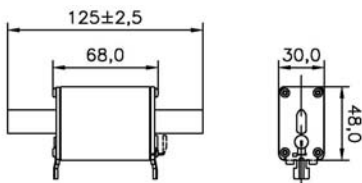

Size 01

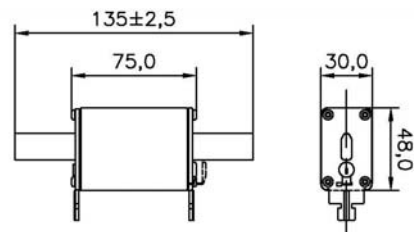

Size 1

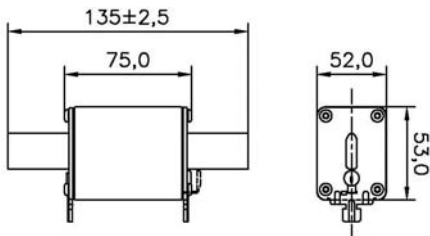

Size 02

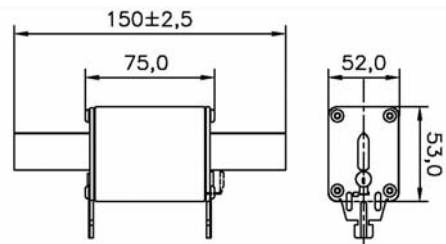

Size 2

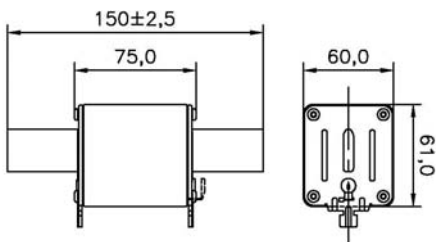

Size 03

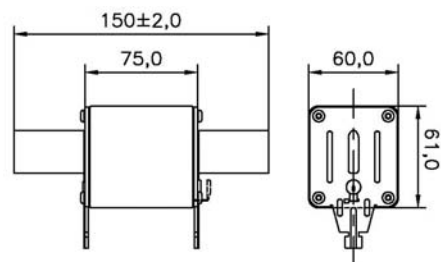

Size 3

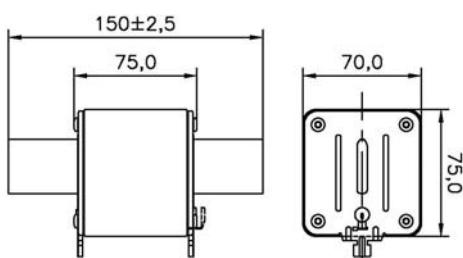

Size 4

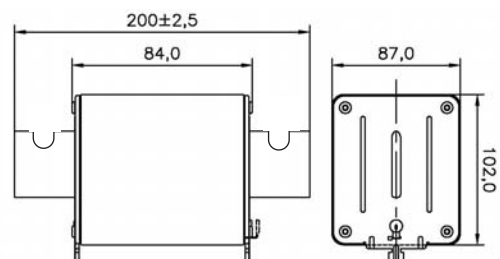

NH Fuse Link Dimensions - mm

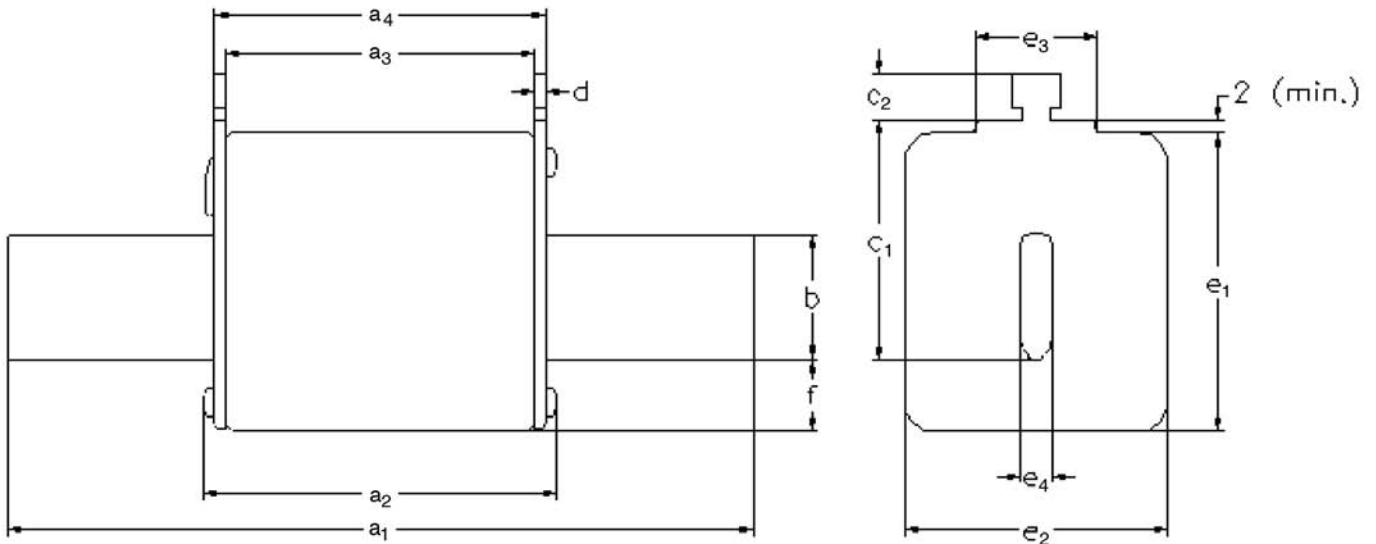

Size	a_1	a_2 (max)	a_3	a_4	b	c_1	c_2	d	e_1 (max)	e_2 (max)	e_3 (max)	e_4	f (max)
000	78.5±1.5	54	45±1.5	49±1.5	15	35	10	2±0.5	41	21	16	6	8
00	78.5±1.5	54	45±1.5	49±1.5	15	35	11	2±0.5	48	30	25	6	15
0	125±2.5	68	62 ^{+3/-1.5}	68 ^{+1.5/-3}	15	35	11	2.5±0.5	48	30	25	6	15
01	135±2.5	75	62±2.5	68±2.5	15	40	11	2.5±0.5	48	30	25	6	15
1	135±2.5	75	62±2.5	68±2.5	20	40	11	2.5±0.5	53	52	25	6	15
02	150±2.5	75	62±2.5	68±2.5	20	48	11	2.5±0.5	53	52	25	6	15
2	150±2.5	75	62±2.5	68±2.5	25	48	11	2.5±0.5	61	60	25	6	15
03	150±2.5	75	62±2.5	68±2.5	25	60	11	2.5±0.5	61	60	25	6	15
3	150±2.5	75	62±2.5	68±2.5	32	60	11	3±0.5	75	70	25	6	18
4	200	84	80	90	50	85	10	3	102	87	-	8	30

Product Range

Voltage	Class	Size	Amps																					Page												
			2	4	6	10	16	20	25	32	35	40	50	63	80	100	125	160	200	224	250	315	355		400	425	500	630	800	1000	1250					
400V	gG	000	■																														13			
		00															■	■																	14	
		01																■	■																15	
		1																	■	■	■														15	
		02																	■	■	■														16	
		2																				■	■	■	■										16	
		03																					■	■	■										17	
		3																									■	■								17
500	gG	000	■																																21	
		00																				■	■												22	
		0																																	23	
		01																																	24	
		1																					■	■	■										24	
		02																																	25	
		2																																		25
		03																																		26
		3																																		26
4																																			27	
690	gG	000	■																																	31
		00																																	31	
		0																																	32	
		1																																	33	
		2																																		34
500	aM	00																																38 to 41		
		0																																38 to 41		
		1																																	38 to 41	
		2																																	38 to 41	
		3																																	38 to 41	
690	aM	000																																38 to 41		
		0																																38 to 41		
		1																																	38 to 41	
		2																																	38 to 41	
		3																																	38 to 41	

■ : Part available, for example Size 00 400V is available in 125 & 160A

Ordering Key

Current rating	100					
NH fuse link		NH				
Utilisation class			G			
Body size				000		
Cooper Bussmann					B	
Insulated metal gripping lugs (optional)						I
Complete part number	100	NH	G	000	B	I

Intuitive Part Number

Cooper Bussmann logical part numbering system provides simple identification of fuse link current, utilisation class, size and voltage, ensuring easy identification on site reducing replacement time and improving network productivity.

400Vac gG/gL - 2 to 630 Amps - Sizes 000 to 3



Description: A square bodied range of industrial fuse links for a wide variety of applications.

Part Number Structure: (amp)NHG(size)B-400.
e.g. 100NHG02B-400

Class of Operation: gL/gG

Standards/Approvals: IEC 60269, VDE 0636, DIN 43620 and CE

Ratings:

- Volts: 400Vac
- Amps: 2 to 630A
- Breaking Capacity: 120kA AC
- Operating Frequency: 45-62Hz

Environmental:

- Recyclable
- RoHS compliant
- Lead and Cadmium free for sizes 000 to 3 (2 to 630A)

Packaging: All fuse links are packed in 3's.

Features:

- Energy savings
- Reliable dual indicator system
- Low temperature rise
- Globally compliant
- Intuitive part numbers

Difference between Insulated Metal Gripping Lugs (IMGL) and standard NH fuse link

IMGL



Lug is voltage free

Standard



Lug is live part

Microswitch for remote indication:

- BVL-50

400Vac

500Vac









690Vac

aM

Accessories

400Vac gG/gL - 2 to 630 Amps - Sizes 000 to 3

Part Numbers

400Vac	Size	Rated Current (Amps)	gG/gL Dual Indicator		Pack Quantity
			Voltage Conducting Metal Gripping Lugs	Voltage-Free Metal Gripping Lugs	
	000	2	2NHG000B-400	2NHG000BI-400	3
		4	4NHG000B-400	4NHG000BI-400	3
		6	6NHG000B-400	6NHG000BI-400	3
		10	10NHG000B-400	10NHG000BI-400	3
		16	16NHG000B-400	16NHG000BI-400	3
		20	20NHG000B-400	20NHG000BI-400	3
		25	25NHG000B-400	25NHG000BI-400	3
		32	32NHG000B-400	32NHG000BI-400	3
		35	35NHG000B-400	35NHG000BI-400	3
		40	40NHG000B-400	40NHG000BI-400	3
		50	50NHG000B-400	50NHG000BI-400	3
		63	63NHG000B-400	63NHG000BI-400	3
	00	125	125NHG00B-400	125NHG00BI-400	3
		160	160NHG00B-400	160NHG00BI-400	3
	01	35	35NHG01B-400	35NHG01BI-400	3
		40	40NHG01B-400	40NHG01BI-400	3
		50	50NHG01B-400	50NHG01BI-400	3
		63	63NHG01B-400	63NHG01BI-400	3
		80	80NHG01B-400	80NHG01BI-400	3
		100	100NHG01B-400	100NHG01BI-400	3
		125	125NHG01B-400	125NHG01BI-400	3
	1	160	160NHG01B-400	160NHG01BI-400	3
		200	200NHG1B-400	200NHG1BI-400	3
		224	224NHG1B-400	224NHG1BI-400	3
	02	250	250NHG1B-400	250NHG1BI-400	3
		35	35NHG02B-400	35NHG02BI-400	3
		40	40NHG02B-400	40NHG02BI-400	3
		50	50NHG02B-400	50NHG02BI-400	3
		63	63NHG02B-400	63NHG02BI-400	3
		80	80NHG02B-400	80NHG02BI-400	3
		100	100NHG02B-400	100NHG02BI-400	3
		125	125NHG02B-400	125NHG02BI-400	3
		160	160NHG02B-400	160NHG02BI-400	3
		200	200NHG02B-400	200NHG02BI-400	3
	2	224	224NHG02B-400	224NHG02BI-400	3
		250	250NHG02B-400	250NHG02BI-400	3
		315	315NHG2B-400	315NHG2BI-400	3
	03	355	355NHG2B-400	355NHG2BI-400	3
		400	400NHG2B-400	400NHG2BI-400	3
		250	250NHG03B-400	250NHG03BI-400	3
		315	315NHG03B-400	315NHG03BI-400	3
	3	355	355NHG03B-400	355NHG03BI-400	3
		400	400NHG03B-400	400NHG03BI-400	3
		500	500NHG3B-400	500NHG3BI-400	3
	3	630	630NHG3B-400	630NH3GBI-400	3

400Vac

500Vac

690Vac

aM

Accessories

400Vac gG/gL - 2 to 100 Amps - Size 000

Time-Current Characteristics

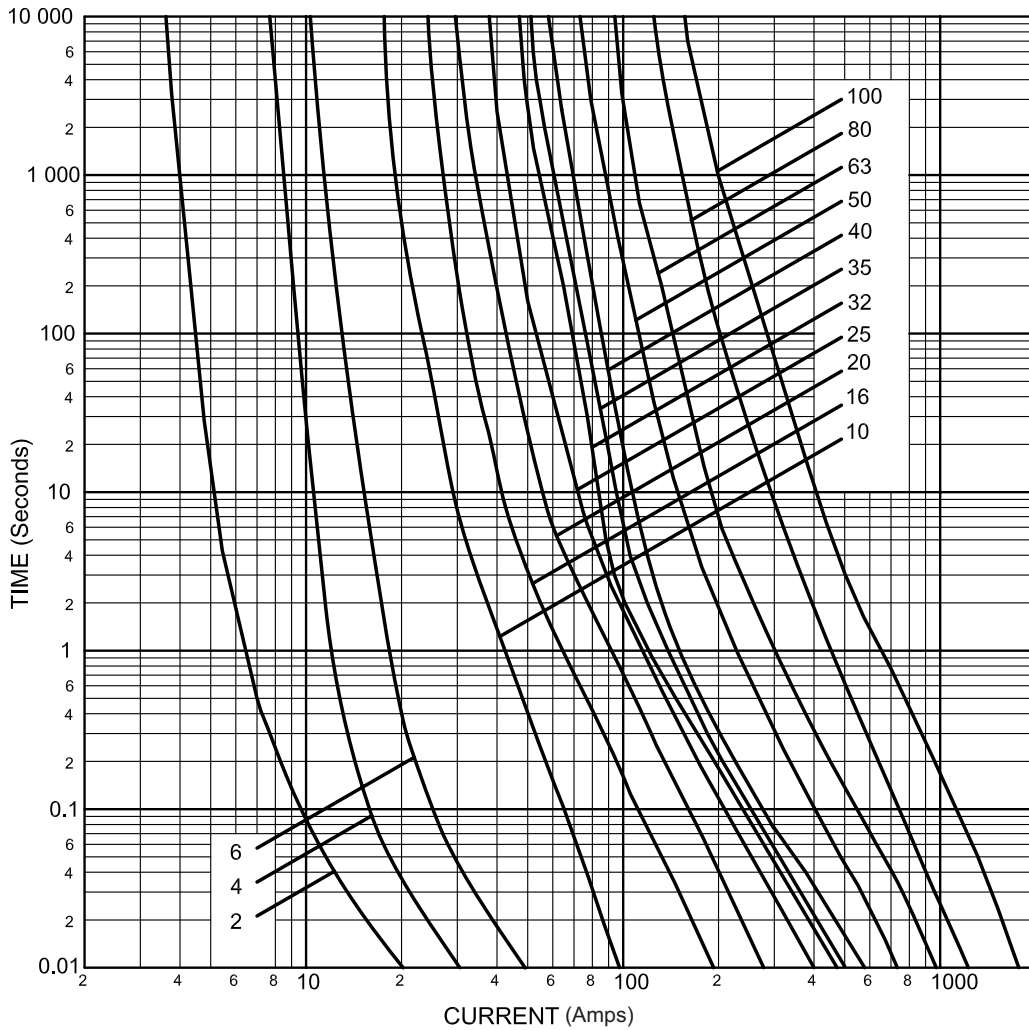

Technical Data

Part Numbers with Metal Gripping Lugs	Part Numbers with Insulated Metal Gripping Lugs	Amp Rating	I^2t (Amps ² Seconds)		Watts Loss	Net Weight per Fuse
			Minimum Pre-arcing	I_1 120kA @ 400Vac		
2NHG000B-400	2NHG000BI-400	2	4	6	3.9	0.133 kg
4NHG000B-400	4NHG000BI-400	4	6	12	1.4	
6NHG000B-400	6NHG000BI-400	6	14	21	2.2	
10NHG000B-400	10NHG000BI-400	10	58	174	1.5	
16NHG000B-400	16NHG000BI-400	16	234	800	2.3	
20NHG000B-400	20NHG000BI-400	20	584	1800	2.2	
25NHG000B-400	25NHG000BI-400	25	1000	2800	3.1	
32NHG000B-400	32NHG000BI-400	32	2400	9600	2.8	
35NHG000B-400	35NHG000BI-400	35	2900	11300	2.8	
40NHG000B-400	40NHG000BI-400	40	4100	16400	3.0	
50NHG000B-400	50NHG000BI-400	50	4000	12000	3.4	
63NHG000B-400	63NHG000BI-400	63	6000	20400	4.5	
80NHG000B-400	80NHG000BI-400	80	9900	35700	4.7	
100NHG000B-400	100NHG000BI-400	100	18100	39800	5.3	

* I_1 is the maximum breaking capacity test at rated voltage according to IEC 60269 requirements

400Vac

500Vac

690Vac

aM

Accessories

400Vac gG/gL - 125 & 160 Amps - Size 00

Time-Current Characteristics

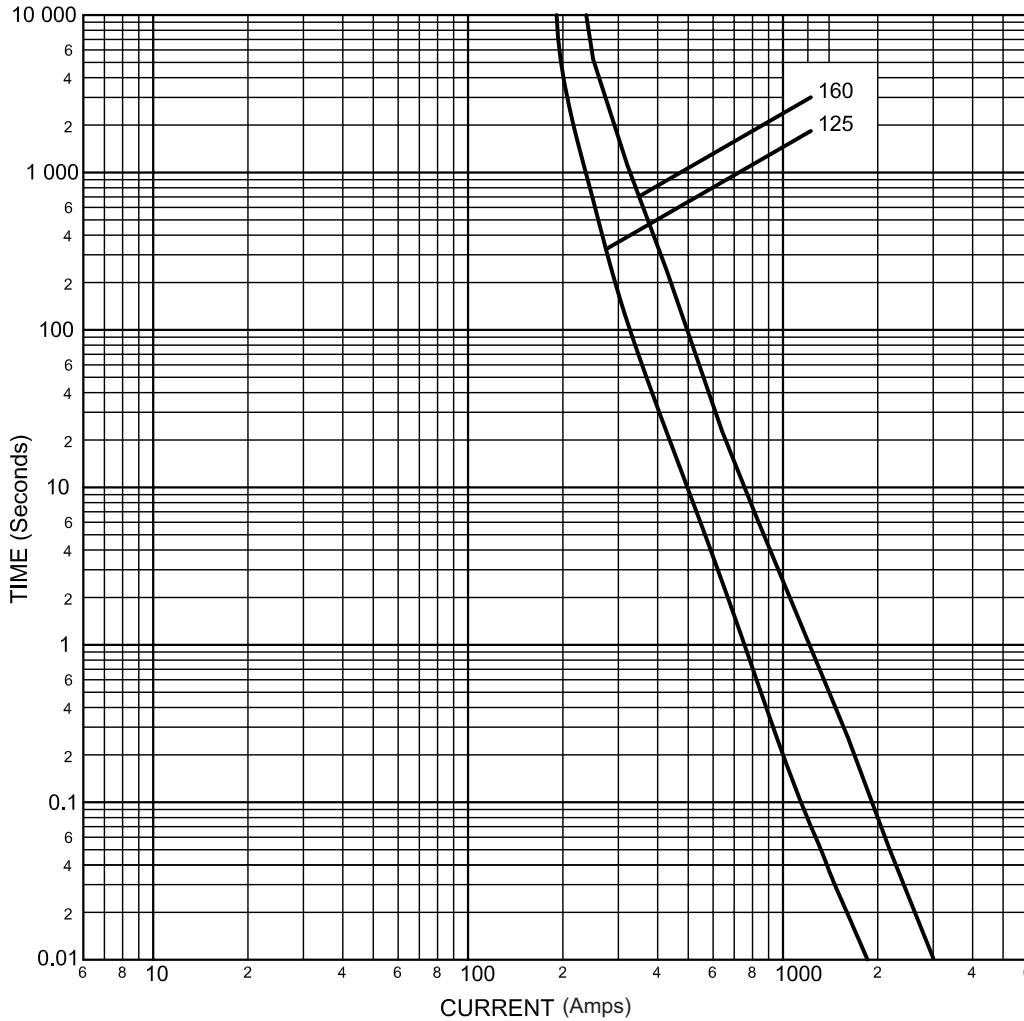

Technical Data

Part Numbers with Metal Gripping Lugs	Part Numbers with Insulated Metal Gripping Lugs	Amps Rating	I ² t (Amps ² Seconds)		Watts Loss	Net Weight per Fuse
			Minimum Pre-arcing	*I ₁ 120kA @ 400Vac		
125NHG00B-400	125NHG00BI-400	125	25000	90000	7.7	0.185 kg
160NHG00B-400	160NHG00BI-400	160	60000	126000	7.8	

* I₁ is the maximum breaking capacity test at rated voltage according to IEC 60269 requirements

400Vac gG/gL - 35 to 250 Amps - Sizes 01 & 1

Time-Current Characteristics

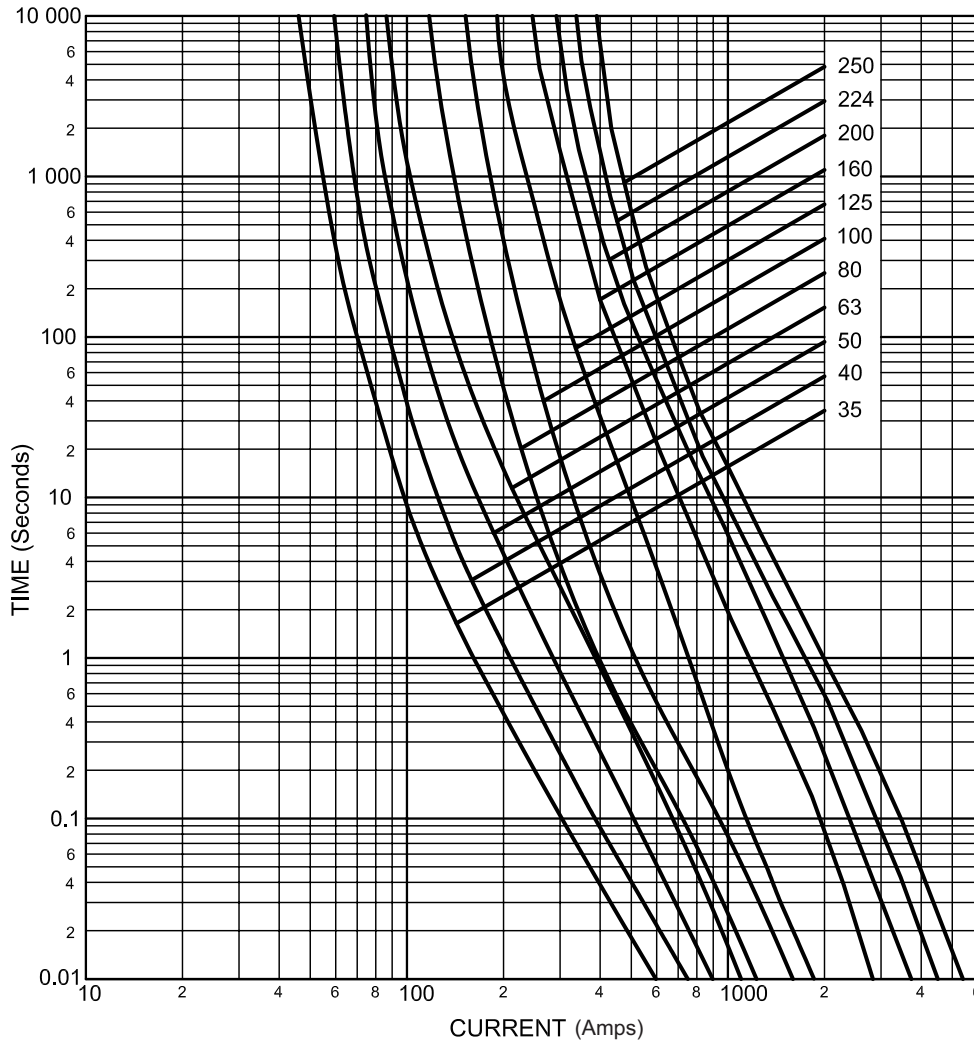

Technical Data

Part Numbers with Metal Gripping Lugs	Part Numbers with Insulated Metal Gripping Lugs	Amp Rating	I ² t (Amps ² Seconds)		Watts Loss	Net Weight per Fuse
			Minimum Pre-arcing	*I ₁ 120kA @ 400Vac		
35NHG01B-400	35NHG01BI-400	35	2400	7600	4.4	0.269kg
40NHG01B-400	40NHG01BI-400	40	3300	10600	5.0	
50NHG01B-400	50NHG01BI-400	50	4200	10400	4.4	
63NHG01B-400	63NHG01BI-400	63	6600	16300	5.6	
80NHG01B-400	80NHG01BI-400	80	9600	33600	6.7	
100NHG01B-400	100NHG01BI-400	100	16000	56000	7.0	
125NHG01B-400	125NHG01BI-400	125	24000	86400	9.0	
160NHG01B-400	160NHG01BI-400	160	53000	111300	10.0	0.387kg
200NHG1B-400	200NHG1BI-400	200	80000	296000	13.0	
224NHG1B-400	224NHG1BI-400	224	125000	462500	13.0	
250NHG1B-400	250NHG1BI-400	250	180000	666000	14.0	

* I₁ is the maximum breaking capacity test at rated voltage according to IEC 60269 requirements

400Vac

500Vac

690Vac

aM

Accessories

400Vac gG/gL - 35 to 400 Amps - Sizes 02 & 2

Time-Current Characteristics

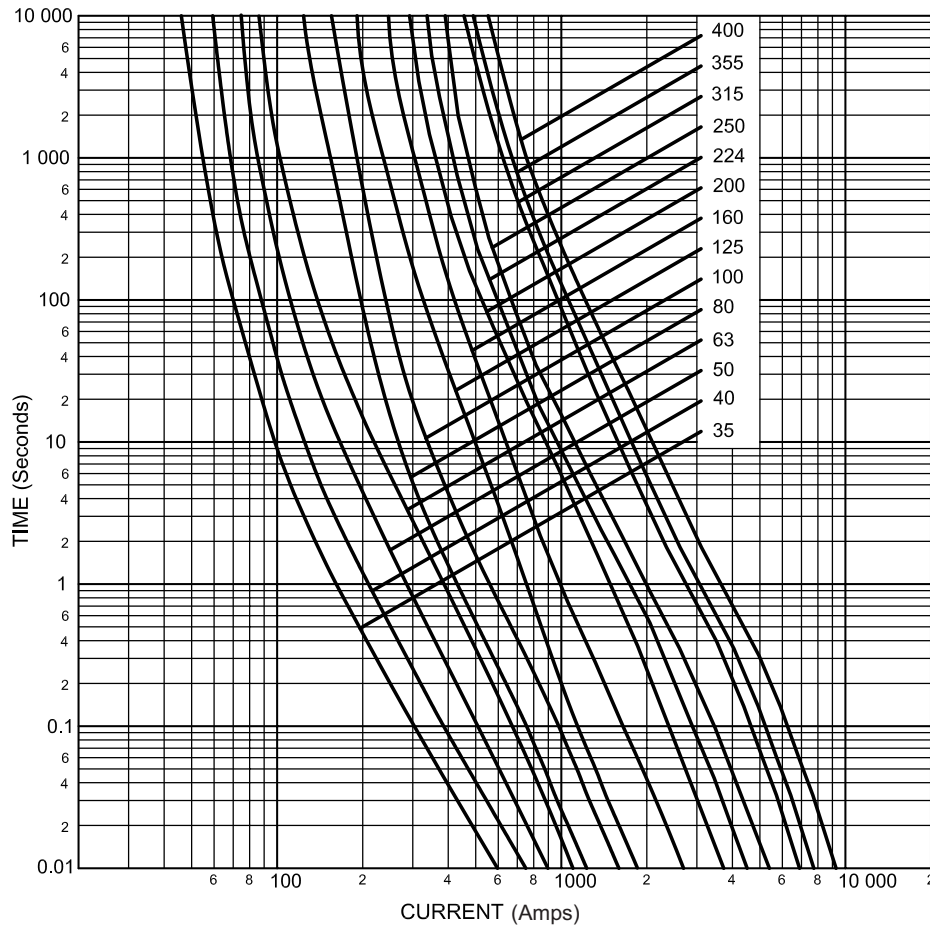

Technical Data

Part Numbers with Metal Gripping Lugs	Part Numbers with Insulated Metal Gripping Lugs	Amp Rating	I ² t (Amps ² Seconds)		Watts Loss	Net Weight per Fuse
			Minimum Pre-arcing	*I ₁ 120kA @ 400Vac		
35NHG02B-400	35NHG02BI-400	35	2400	7600	4.4	0.402kg
40NHG02B-400	40NHG02BI-400	40	3300	10600	5.0	
50NHG02B-400	50NHG02BI-400	50	4200	10400	4.8	
63NHG02B-400	63NHG02BI-400	63	6600	16300	5.5	
80NHG02B-400	80NHG02BI-400	80	10000	34800	5.5	
100NHG02B-400	100NHG02BI-400	100	16000	56000	7.0	
125NHG02B-400	125NHG02BI-400	125	24000	86400	9.0	
160NHG02B-400	160NHG02BI-400	160	50000	185000	10.0	
200NHG02B-400	200NHG02BI-400	200	80000	296000	13.0	
224NHG02B-400	224NHG02BI-400	224	125000	426520	13.0	
250NHG02B-400	250NHG02BI-400	250	180000	666000	14.0	
315NHG2B-400	315NHG2BI-400	315	280000	924000	19.0	0.630kg
355NHG2B-400	355NHG2BI-400	355	350000	1155000	22.0	
400NHG2B-400	400NHG2BI-400	400	507000	1673100	24.0	

* I₁ is the maximum breaking capacity test at rated voltage according to IEC 60269 requirements

400Vac

500Vac

690Vac

aM

Accessories

400Vac gG/gL - 250 to 630 Amps - Sizes 03 & 3

Time-Current Characteristics

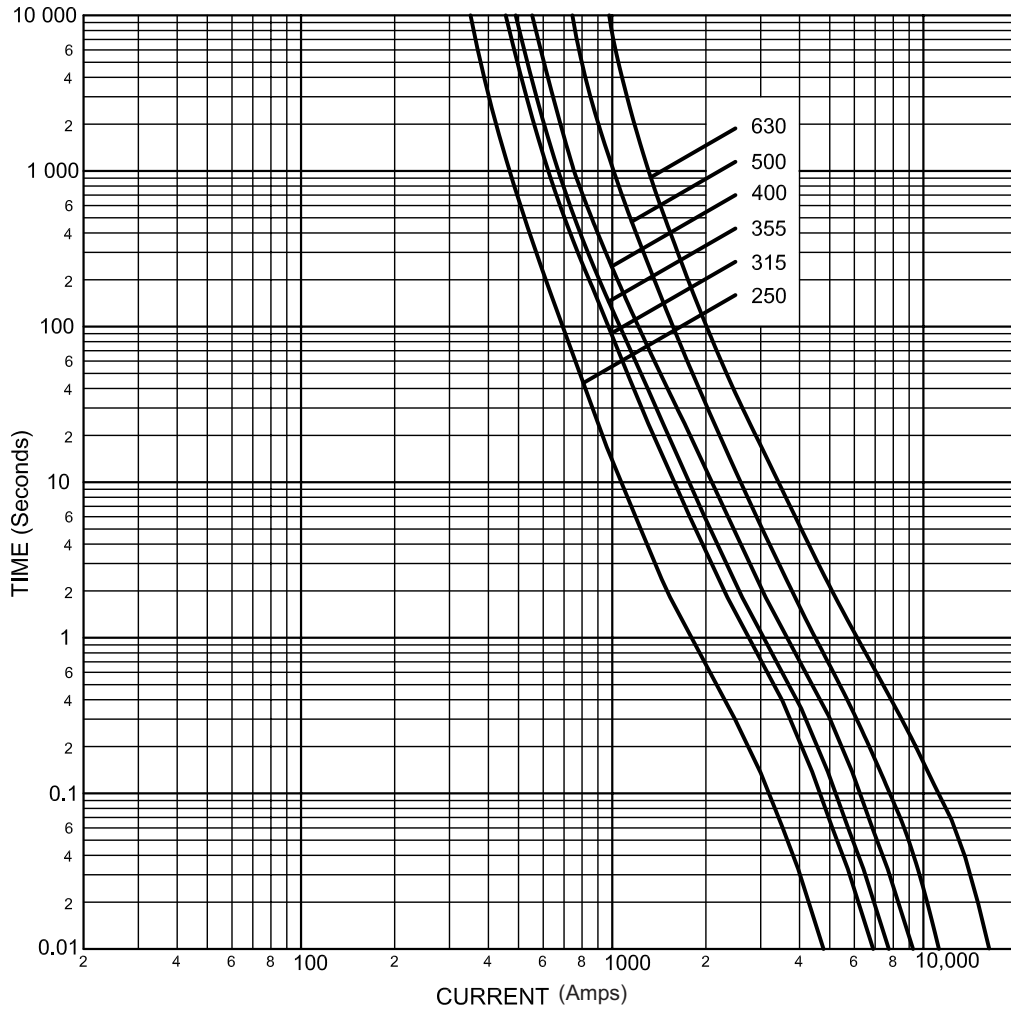

Technical Data

Part Numbers with Metal Gripping Lugs	Part Numbers with Insulated Metal Gripping Lugs	Amp Rating	I ² t (Amps ² Seconds)		Watts Loss	Net Weight per Fuse
			Minimum Pre-arcing	*I ₁ 120kA @ 400Vac		
250NHG03B-400	250NHG03BI-400	250	115000	379500	18	0.634kg
315NHG03B-400	315NHG03BI-400	315	280000	924000	19	
355NHG03B-400	355NHG03BI-400	355	350000	1155000	22	
400NHG03B-400	400NHG03BI-400	400	507000	1673100	24	
500NHG3B-400	500NHG3BI-400	500	686000	2605200	28	1.043kg
630NHG3B-400	630NHG3BI-400	630	1590000	6201000	36	

* I₁ is the maximum breaking capacity test at rated voltage according to IEC 60269 requirements

400Vac

500Vac

690Vac

aM

Accessories

400Vac gG/gL - 2 to 630 Amps - Sizes 000 to 3

Cut-Off Current Characteristics

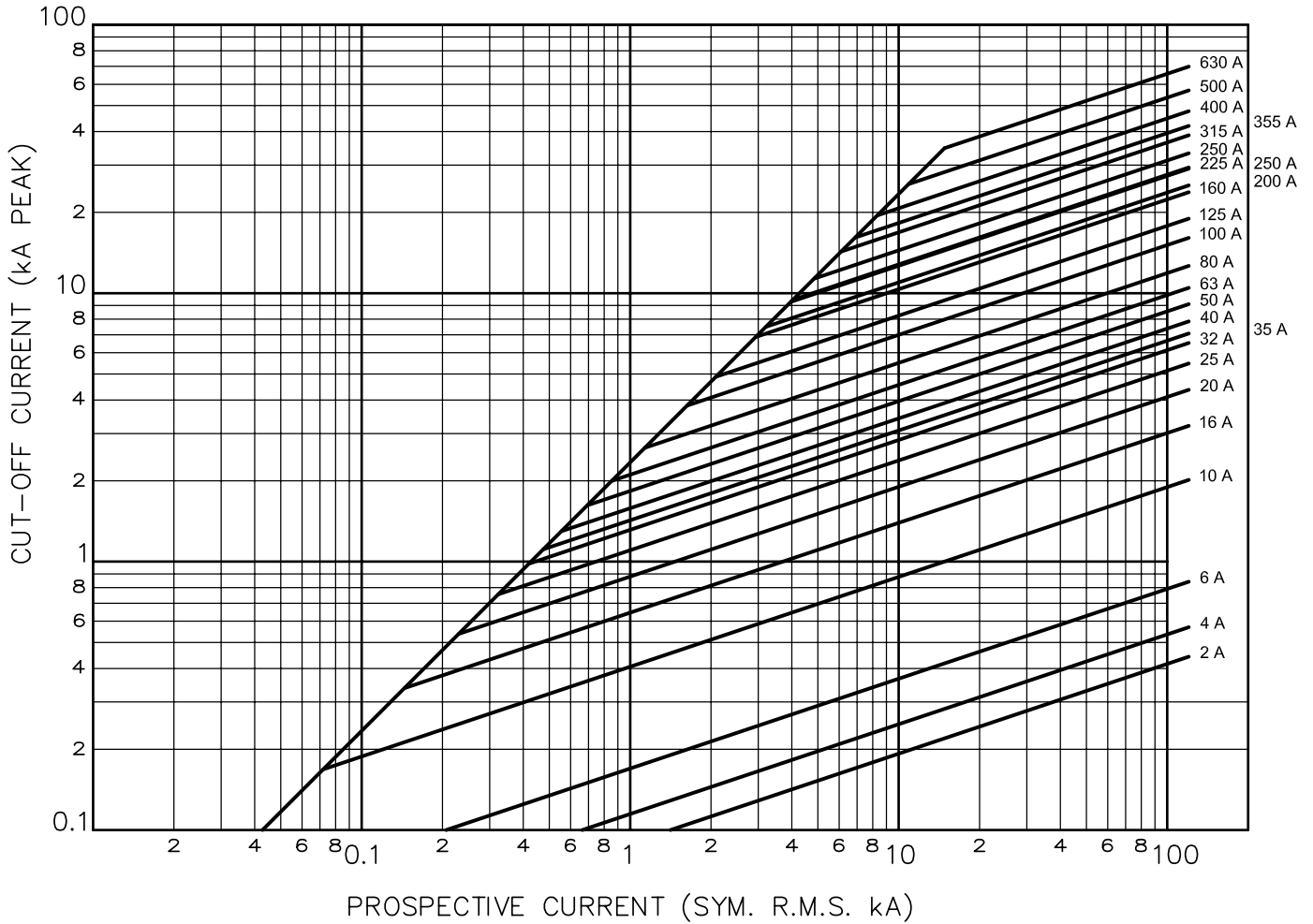

500Vac gG/gL - 2 to 1250 Amps - Sizes 000 to 4



Description: A square bodied range of industrial fuse links for a wide variety of applications.

Part Number Structure: (amp)NHG(size)B, e.g. 100NHG01B

Class of Operation: gL/gG

Standards/Approvals: IEC 60269, VDE 0636, DIN 43620, and CE

Ratings:

- Volts: 500Vac / 250Vdc
- Amps: 2 to 1250A
- Breaking Capacity: 120kA AC
- Operating Frequency: 45-62Hz

Environmental:

- Recyclable
- RoHS compliant
- Lead and Cadmium free for sizes 000 to 4 (2A to 1250A)

Packaging: All fuse links are packed in 3's.

Features:

- Energy savings
- Reliable dual indicator system
- Low temperature rise
- Globally compliant
- Intuitive part numbers

Difference between Insulated Metal Gripping Lugs (IMGL) and standard NH fuse link

IMGL



Lug is voltage free

Standard



Lug is live part

Microswitch for remote indication:

- BVL-50

400Vac

500Vac

690Vac

aM

Accessories

500Vac gG/gL - 2 to 1250 Amps - Sizes 000 to 4

Part Numbers

500Vac / 250Vdc	Size	Rated Current (Amps)	gG/gL Dual Indicator		Pack Quantity		
			Voltage Conducting Metal Gripping Lugs	Voltage-Free Metal Gripping Lugs			
	000	2	2NHG00B	2NHG00BI	3		
		4	4NHG00B	4NHG00BI	3		
		6	6NHG00B	6NHG00BI	3		
		10	10NHG00B	10NHG00BI	3		
		16	16NHG00B	16NHG00BI	3		
		20	20NHG00B	20NHG00BI	3		
		25	25NHG00B	25NHG00BI	3		
		32	32NHG00B	32NHG00BI	3		
		35	35NHG00B	35NHG00BI	3		
		40	40NHG00B	40NHG00BI	3		
		50	50NHG00B	50NHG00BI	3		
		63	63NHG00B	63NHG00BI	3		
		80	80NHG00B	80NHG00BI	3		
		100	100NHG00B	100NHG00BI	3		
		125	125NHG00B	125NHG00BI	3		
		160	160NHG00B	160NHG00BI	3		
0	0	10	10NHG0B	-	3		
		16	16NHG0B	-	3		
		20	20NHG0B	-	3		
		25	25NHG0B	-	3		
		32	32NHG0B	-	3		
		35	35NHG0B	-	3		
		40	40NHG0B	-	3		
		50	50NHG0B	-	3		
		63	63NHG0B	-	3		
		80	80NHG0B	-	3		
		100	100NHG0B	-	3		
		125	125NHG0B	-	3		
		160	160NHG0B	-	3		
		01	01	10	10NHG01B	10NHG01BI	3
				16	16NHG01B	16NHG01BI	3
				20	20NHG01B	20NHG01BI	3
25	25NHG01B			25NHG01BI	3		
32	32NHG01B			32NHG01BI	3		
35	35NHG01B			35NHG01BI	3		
40	40NHG01B			40NHG01BI	3		
50	50NHG01B			50NHG01BI	3		
63	63NHG01B			63NHG01BI	3		
80	80NHG01B			80NHG01BI	3		
100	100NHG01B			100NHG01BI	3		
125	125NHG01B			125NHG01BI	3		
160	160NHG01B			160NHG01BI	3		
1	1			200	200NHG1B	200NHG1BI	3
				224	224NHG1B	224NHG1BI	3
				250	250NHG1B	250NHG1BI	3
		35	35NHG02B	35NHG02BI	3		
02	02	40	40NHG02B	40NHG02BI	3		
		50	50NHG02B	50NHG02BI	3		
		63	63NHG02B	63NHG02BI	3		
		80	80NHG02B	80NHG02BI	3		
		100	100NHG02B	100NHG02BI	3		
		125	125NHG02B	125NHG02BI	3		
		160	160NHG02B	160NHG02BI	3		
		200	200NHG02B	200NHG02BI	3		
2	2	224	224NHG02B	224NHG02BI	3		
		250	250NHG02B	250NHG02BI	3		
		315	315NHG2B	315NHG2BI	3		
		355	355NHG2B	355NHG2BI	3		
03	03	400	400NHG2B	400NHG2BI	3		
		250	250NHG03B	250NHG03BI	3		
		315	315NHG03B	315NHG03BI	3		
		355	355NHG03B	355NHG03BI	3		
3	3	400	400NHG03B	400NHG03BI	3		
		500	500NHG3B	500NHG3BI	3		
		630	630NHG3B	-	3		
		500	500NHG4G	-	1		
4	4	630	630NHG4G	-	1		
		800	800NHG4G	-	1		
		1000	1000NHG4G	-	1		
		1250	1250NHG4G	-	1		
		Single Indicator Slotted End Tags					

400Vac

500Vac

690Vac

aM

Accessories

500Vac gG/gL - 2 to 100 Amps - Size 000

Time-Current Characteristics

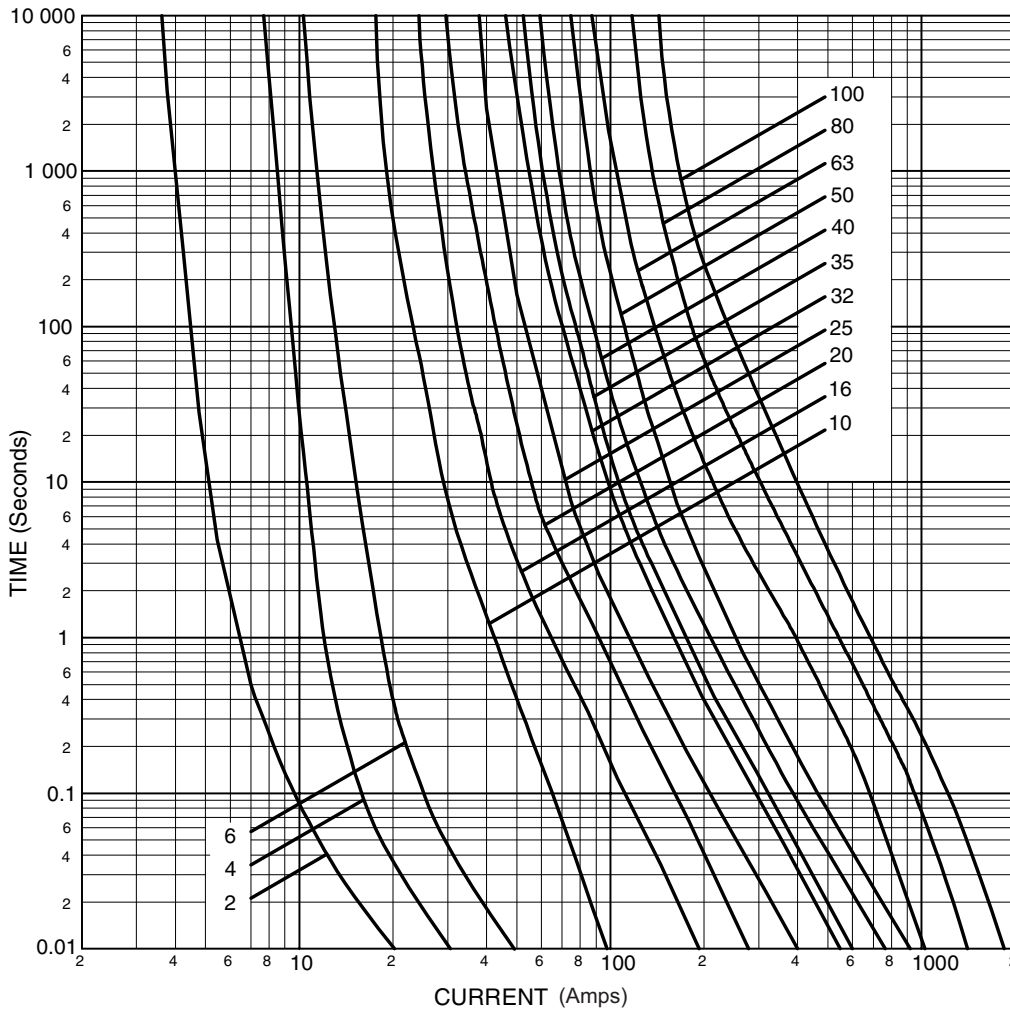

Technical Data

Part Numbers with Metal Gripping Lugs	Part Numbers with Insulated Metal Gripping Lugs	Amp Rating	I^2t (Amps ² Seconds)			Watts Loss	Net Weight per Fuse
			Minimum Pre-arcing	$20 \times I_n$ @ 500Vac	I_1 120kA @ 500Vac		
2NHG000B	2NHG000BI	2	4	-	6	3.9	0.13 kg
4NHG000B	4NHG000BI	4	6	-	12	1.8	
6NHG000B	6NHG000BI	6	14	-	21	2.0	
10NHG000B	10NHG000BI	10	58	290	252	1.5	
16NHG000B	16NHG000BI	16	234	1170	1000	2.3	
20NHG000B	20NHG000BI	20	584	3000	2400	2.2	
25NHG000B	25NHG000BI	25	1000	4600	3700	2.8	
32NHG000B	32NHG000BI	32	2400	11800	9400	3.7	
35NHG000B	35NHG000BI	35	2400	11800	9400	3.7	
40NHG000B	40NHG000BI	40	3300	16500	13200	4.0	
50NHG000B	50NHG000BI	50	5600	27800	16700	4.9	
63NHG000B	63NHG000BI	63	6300	24900	18700	4.6	
80NHG000B	80NHG000BI	80	9800	38900	29200	6.3	
100NHG000B	100NHG000BI	100	18100	72300	54300	7.4	

* I_1 is the maximum breaking capacity test at rated voltage according to IEC 60269 requirements

400Vac

500Vac

690Vac

aM

Accessories

500Vac gG/gL - 125 & 160 Amps - Size 00

Time-Current Characteristics

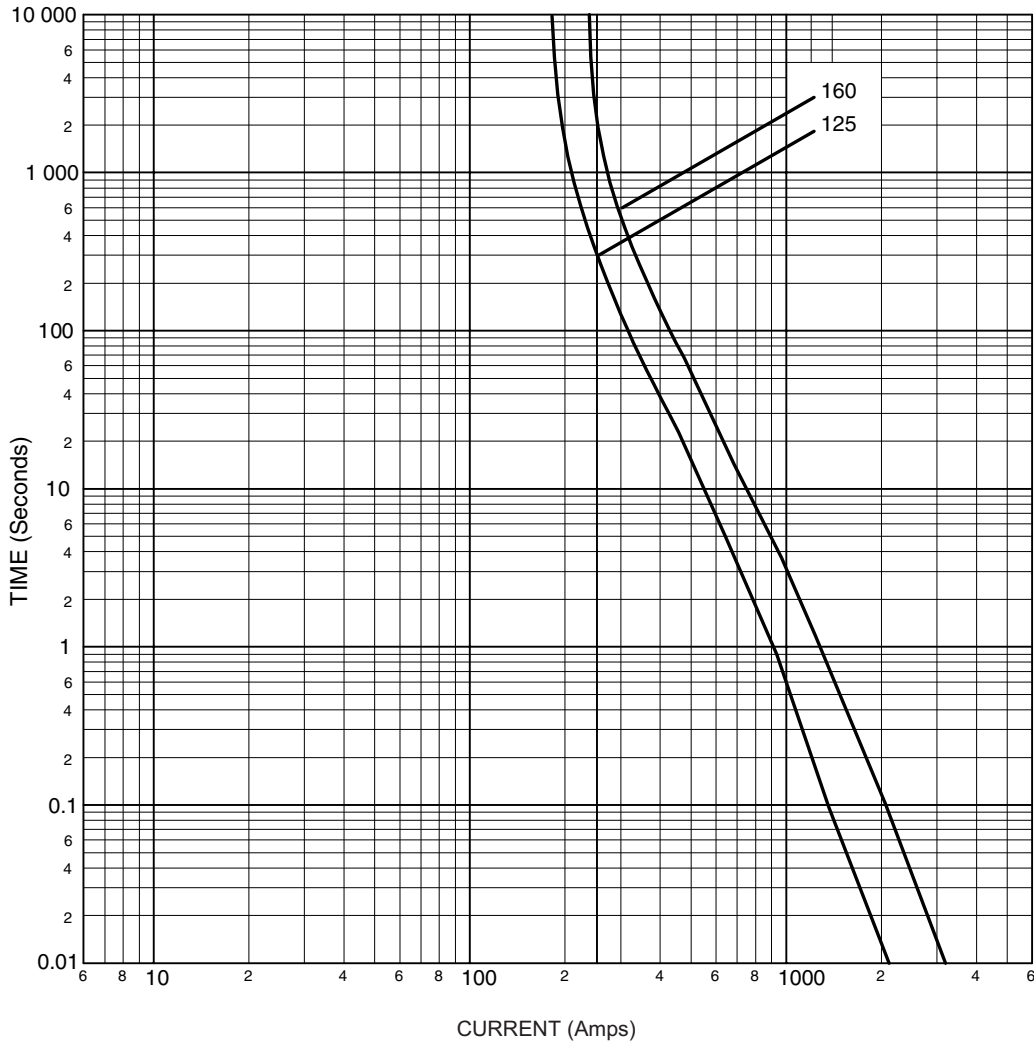

Technical Data

Part Numbers with Metal Gripping Lugs	Part Numbers with Insulated Metal Gripping Lugs	Amp Rating	I ² t (Amps ² Seconds)			Watts Loss	Net Weight per Fuse
			Minimum Pre-arcing	20 x I _n @ 500Vac	*I ₁ 120kA @ 500Vac		
125NHG00B	125NHG00BI	125	25000	125000	80000	11.2	0.190 kg
160NHG00B	160NHG00BI	160	62000	310000	204600	11.2	

* I₁ is the maximum breaking capacity test at rated voltage according to IEC 60269 requirements

400Vac

500Vac

690Vac

aM

Accessories

500Vac gG/gL - 6 to 160 Amps - Size 0

Time-Current Characteristics

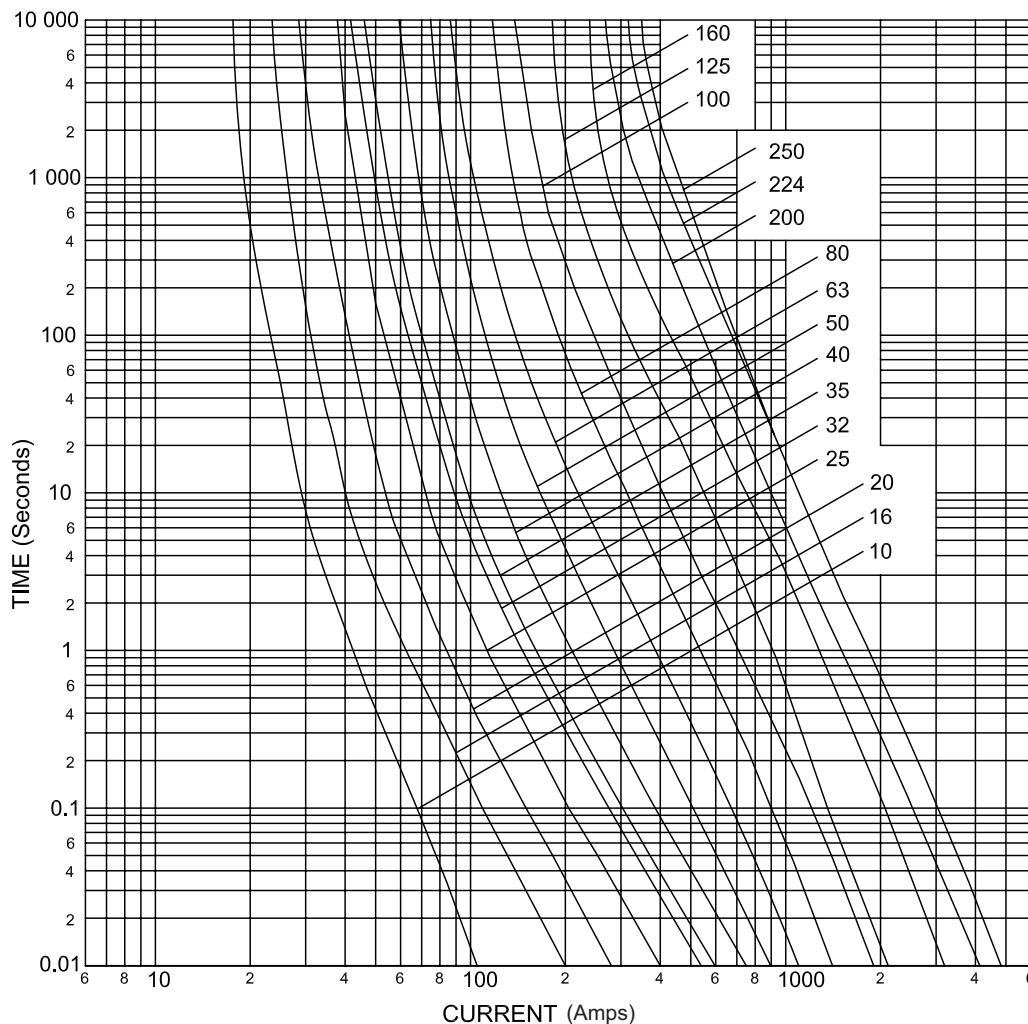

Technical Data

Part Number	Amp Rating	I ² t (Amps ² Seconds)			Watts Loss	Net Weight per Fuse
		Minimum Pre-arcing	20 x I _n @ 500Vac	*I ₁ 120kA @ 500Vac		
10NHG0B	10	58	290	240	2.0	0.26kg
16NHG0B	16	240	1200	1000	3.0	
20NHG0B	20	490	2500	2000	3.6	
25NHG0B	25	1200	5600	4500	4.0	
32NHG0B	32	1800	9000	7200	5.1	
35NHG0B	35	2400	11800	9400	5.2	
40NHG0B	40	3300	16500	13200	5.6	
50NHG0B	50	5600	22300	16700	7.0	
63NHG0B	63	6600	26100	19600	7.0	
80NHG0B	80	9800	38900	29200	7.9	
100NHG0B	100	20600	82300	61700	9.2	
125NHG0B	125	25000	125000	72500	13.1	
160NHG0B	160	62000	310000	179800	14.1	

* I₁ is the maximum breaking capacity test at rated voltage according to IEC 60269 requirements

400Vac

500Vac

690Vac

aM

Accessories

500Vac gG/gL - 10 to 250 Amps - Sizes 01 & 1

Time-Current Characteristics

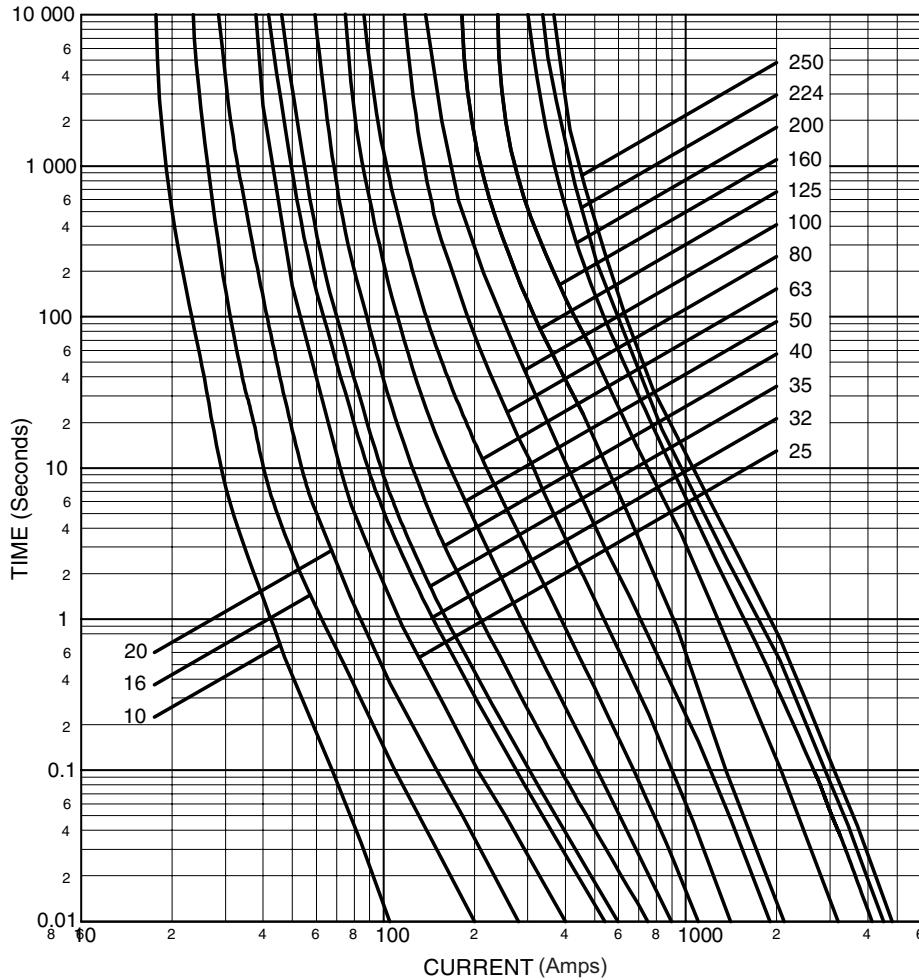

Technical Data

Part Numbers with Metal Gripping Lugs	Part Numbers with Insulated Metal Gripping Lugs	Amp Rating	I ² t (Amps ² Seconds)			Watts Loss	Net Weight per Fuse
			Minimum Pre-arcing	20 x I _n @ 500Vac	*I ₁ 120kA @ 500Vac		
10NHG01B	10NHG01BI	10	58	300	300	2.0	0.270kg
16NHG01B	16NHG01BI	16	240	1200	1000	3.0	
20NHG01B	20NHG01BI	20	490	2500	2000	3.6	
25NHG01B	25NHG01BI	25	1200	5600	4500	4.0	
32NHG01B	32NHG01BI	32	1800	9000	7200	5.1	
35NHG01B	35NHG01BI	35	2400	11800	9400	5.2	
40NHG01B	40NHG01BI	40	3300	16500	13200	5.6	
50NHG01B	50NHG01BI	50	5600	22300	16700	7.0	
63NHG01B	63NHG01BI	63	6600	26100	19600	7.0	
80NHG01B	80NHG01BI	80	9800	38900	29200	7.9	
100NHG01B	100NHG01BI	100	20600	82300	61700	9.2	
125NHG01B	125NHG01BI	125	25000	125000	72500	13.1	
160NHG01B	160NHG01BI	160	62000	310000	179800	14.1	
200NHG1B	200NHG1BI	200	97000	368600	291000	17.0	
224NHG1B	224NHG1BI	224	124000	471200	372000	19.0	
250NHG1B	250NHG1BI	250	151300	574900	453800	22.0	

* I₁ is the maximum breaking capacity test at rated voltage according to IEC 60269 requirements

500Vac gG/gL - 35 to 400 Amps - Sizes 02 & 2

Time-Current Characteristics

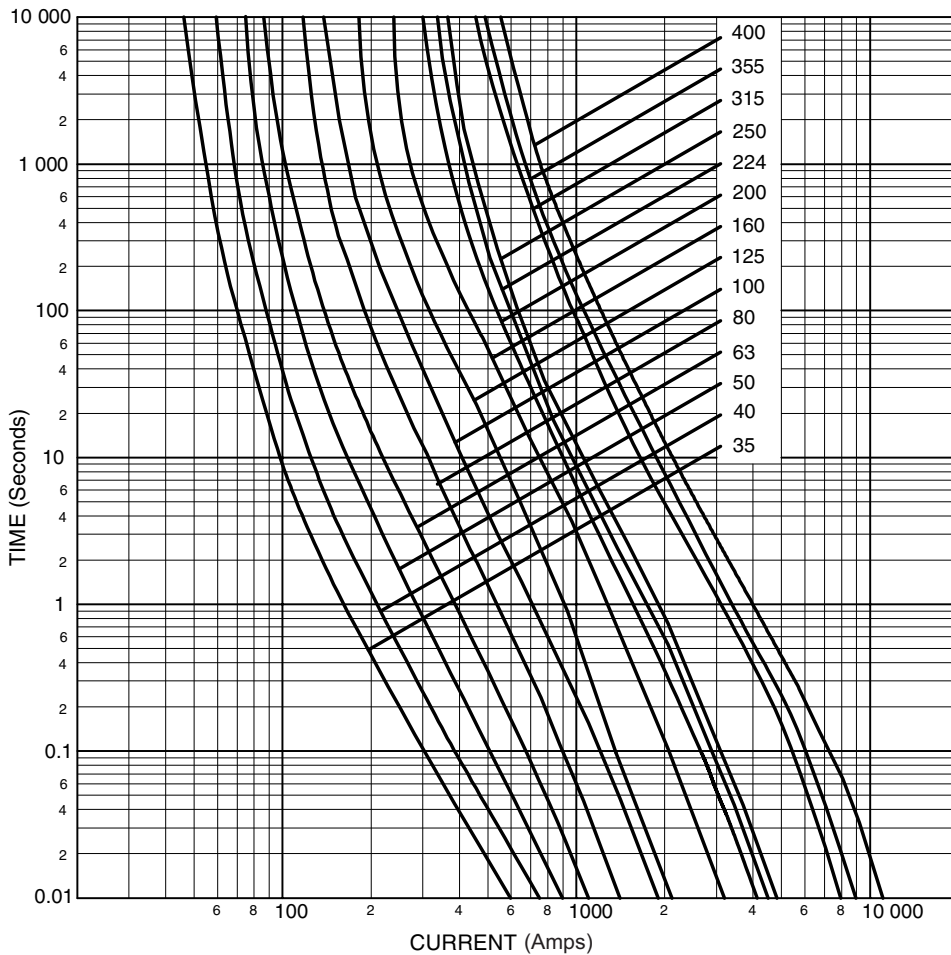

400Vac

500Vac

690Vac

aM

Accessories

Technical Data

Part Numbers with Metal Gripping Lugs	Part Numbers with Insulated Metal Gripping Lugs	Amp Rating	I ² t (Amps ² Seconds)			Watts Loss	Net Weight per Fuse
			Minimum Pre-arcing	20 x I _n @ 500Vac	*I ₁ 120kA @ 500Vac		
35NHG02B	35NHG02BI	35	2400	11800	9400	4.7	0.402kg
40NHG02B	40NHG02BI	40	3300	16500	13200	5.2	
50NHG02B	50NHG02BI	50	5600	22300	16700	7.0	
63NHG02B	63NHG02BI	63	6600	26100	19600	7.0	
80NHG02B	80NHG02BI	80	9800	38900	29200	8.2	
100NHG02B	100NHG02BI	100	20600	82300	61700	9.5	
125NHG02B	125NHG02BI	125	25000	100000	72500	12.5	
160NHG02B	160NHG02BI	160	62000	248000	179800	13.3	
200NHG02B	200NHG02BI	200	96900	367900	290500	18.0	
224NHG02B	224NHG02BI	224	124000	472000	372000	20.0	
250NHG02B	250NHG02BI	250	151300	574900	453800	23.0	
315NHG2B	315NHG2BI	315	361700	1446500	940300	26.0	0.630kg
355NHG2B	355NHG2BI	355	446500	1785800	1160800	31.0	
400NHG2B	400NHG2BI	400	642900	2571500	1671500	34.0	

* I₁ is the maximum breaking capacity test at rated voltage according to IEC 60269 requirements

500Vac gG/gL - 250 to 630 Amps - Sizes 03 & 3

Time-Current Characteristics

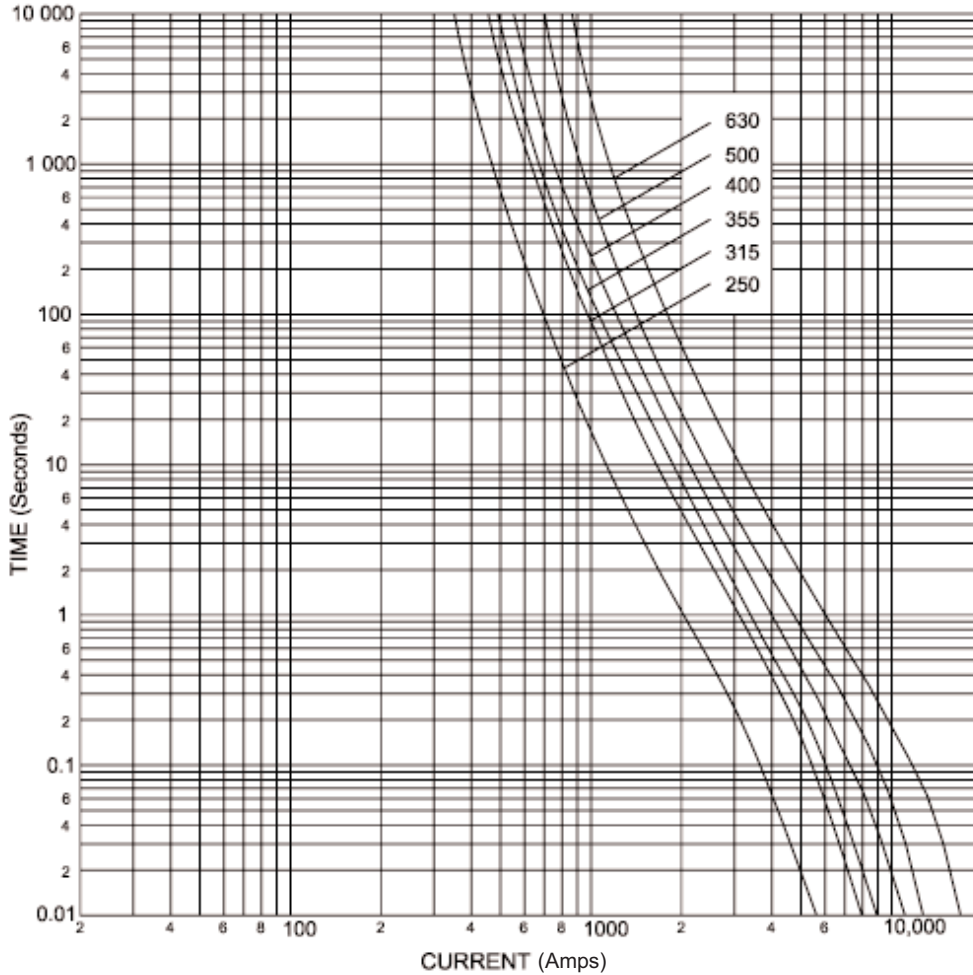

Technical Data

Part Numbers with Metal Gripping Lugs	Part Numbers with Insulated Metal Gripping Lugs	Amp Rating	I ² t (Amps ² Seconds)			Watts Loss	Net Weight per Fuse
			Minimum Pre-arcing	20 x I _n @ 500Vac	*I ₁ 120kA @ 500Vac		
250NHG03B	250NHG03BI	250	160800	642900	417900	23.0	0.64kg
315NHG03B	315NHG03BI	315	361700	1446500	940300	26.0	
355NHG03B	355NHG03BI	355	446500	1785800	1160800	30.0	
400NHG03B	400NHG03BI	400	642900	2571500	1671500	35.0	
500NHG3B	500NHG3BI	500	886000	3898400	2923800	37.0	1.050kg
630NHG3B	630NHG3BI	630	1590000	6996000	5406000	46.0	

* I₁ is the maximum breaking capacity test at rated voltage according to IEC 60269 requirements

400Vac

500Vac

690Vac

aM

Accessories

500Vac gG/gL - 500 to 1250 Amps - Size 4

Time-Current Characteristics

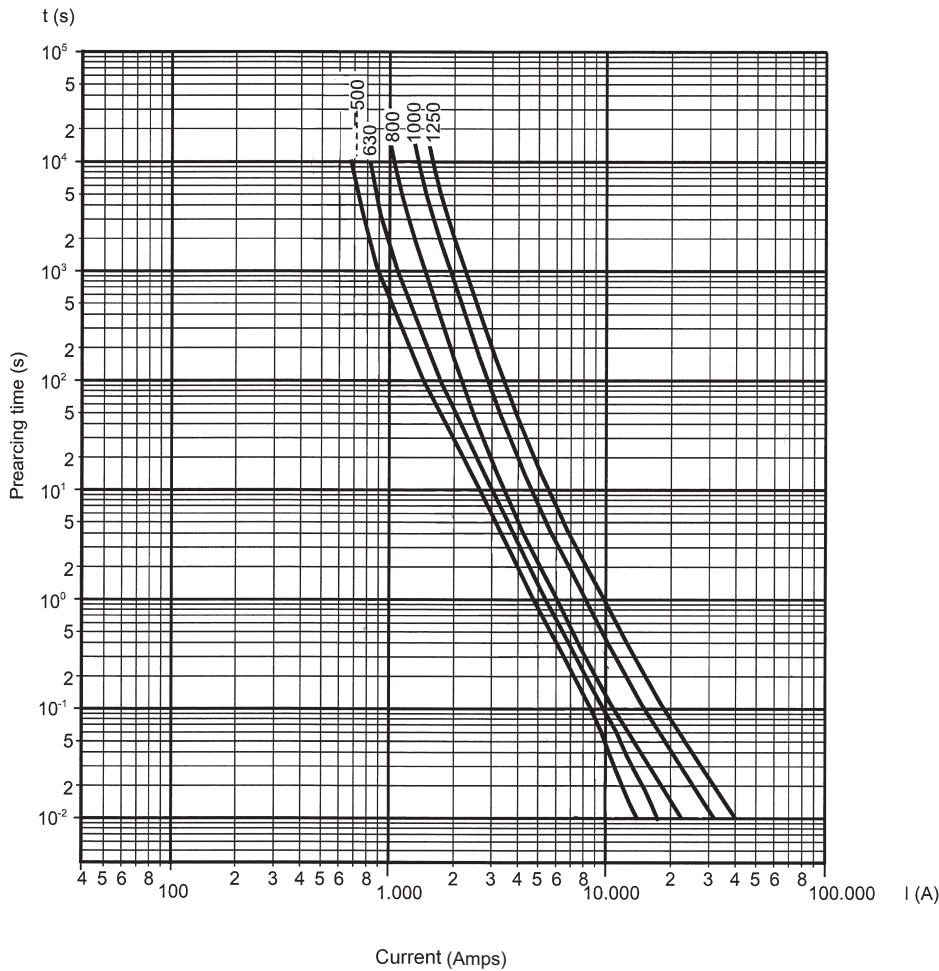

Technical Data

Part Numbers with Metal Gripping Lugs	Amp Rating	I ² t (Amps ² Seconds)		Watts Loss	Net Weight per Fuse
		Minimum Pre-arcing	*I ₁ 120kA @ 500Vac		
500NHG4G	500	800,000	3,850,000	37.0	2.2kg
630NHG4G	630	880,000	4,100,000	47.0	
800NHG4G	800	1,500,000	6,480,000	68.0	
1000NHG4G	1000	4,800,000	13,000,000	80.0	
1250NHG4G	1250	7,000,000	18,000,000	108.0	

* I₁ is the maximum breaking capacity test at rated voltage according to IEC 60269 requirements

400Vac

500Vac

690Vac

aM

Accessories

500Vac gG/gL - 2 to 630 Amps - Sizes 000 to 3

Cut-Off Current Characteristics

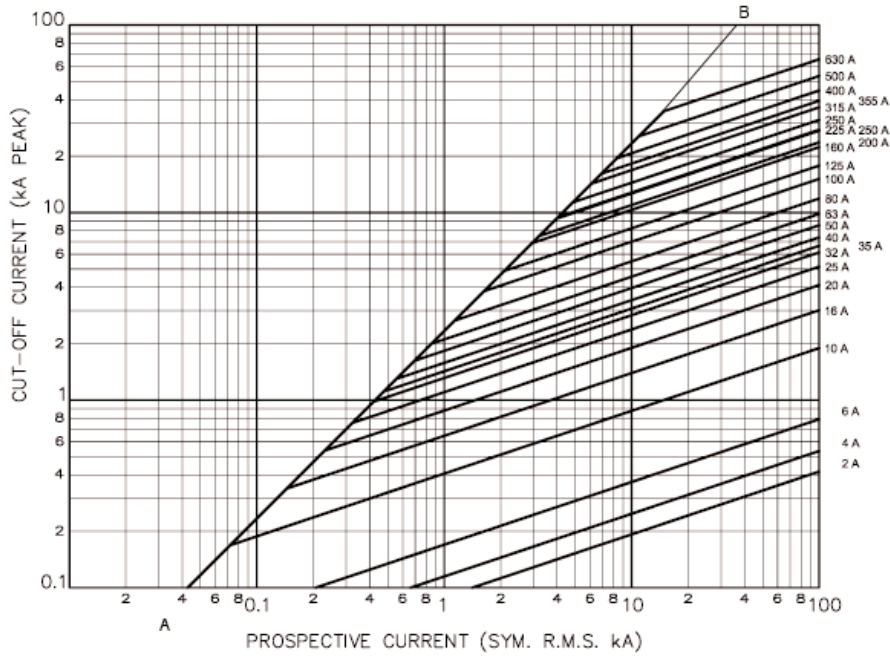

500Vac gL/gG - 630 to 1250 Amps - Size 4

Cut-Off Current Characteristics

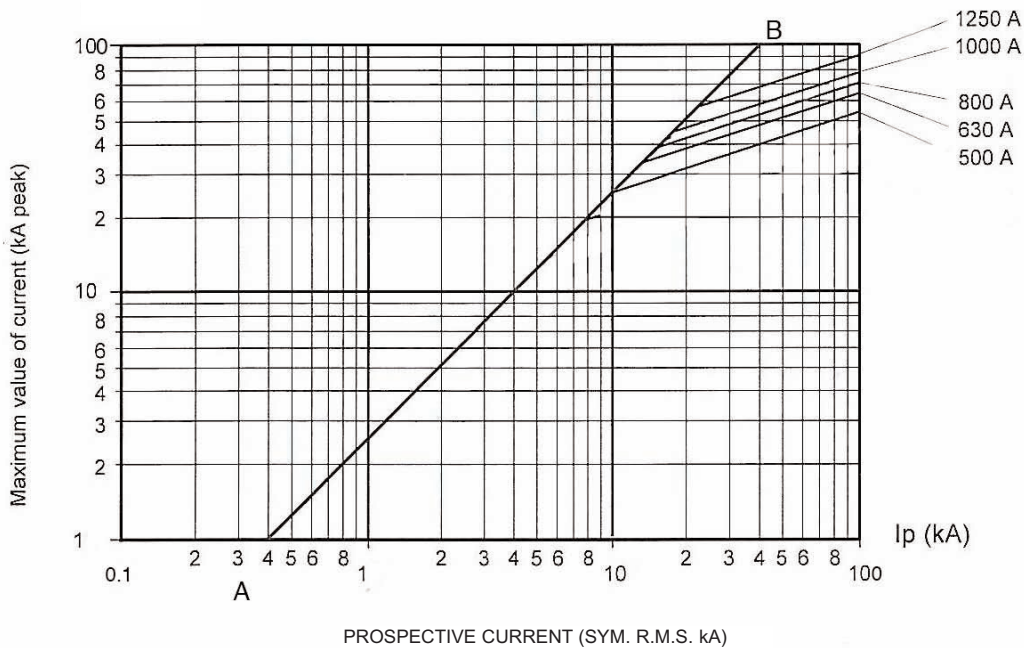

690Vac gG/gL - 2 to 500 Amps - Sizes 000 to 3



Description: A square bodied range of industrial fuse links for a wide variety of applications.

Part Number Structure: (amp)NHG(size)B-690,
e.g. 100NHG00B-690

Class of Operation: gL/gG

Standards/Approvals: IEC 60269, DIN 43620

Ratings:

- Volts: 690Vac
- Amps: 2 to 500A
- Breaking Capacity: 120kA AC
- Operating Frequency: 45-62Hz

Environmental:

- Recyclable
- RoHS compliant
- Lead and Cadmium free for sizes 000 to 3 (2 to 500A)

Packaging: All fuse links are packed in 3's.

Features:

- Energy savings
- Reliable dual indicator system
- Low temperature rise
- Globally compliant
- Intuitive part numbers

Microswitch for remote indication:

- BVL-50

400Vac

500Vac

690Vac

aM

Accessories

690Vac gG/gL - 2 to 500 Amps - Sizes 000 to 3

Part Numbers

690Vac / 250Vdc	Size	Rated Current (Amps)	gG/gL Dual Indicator	Pack Quantity
			Voltage Conducting Metal Gripping Lugs	
	000	2	2NHG00B-690	3
		4	4NHG00B-690	3
		6	6NHG00B-690	3
		10	10NHG00B-690	3
		16	16NHG00B-690	3
		20	20NHG00B-690	3
		25	25NHG00B-690	3
		32	32NHG00B-690	3
		40	40NHG00B-690	3
	00	50	50NHG00B-690	3
		63	63NHG00B-690	3
		80	80NHG00B-690	3
		100	100NHG00B-690	3
		125	125NHG00B-690	3
	0	6	6NHG0B-690	3
		10	10NHG0B-690	3
16		16NHG0B-690	3	
20		20NHG0B-690	3	
25		25NHG0B-690	3	
32		32NHG0B-690	3	
35		35NHG0B-690	3	
40		40NHG0B-690	3	
50		50NHG0B-690	3	
63		63NHG0B-690	3	
80		80NHG0B-690	3	
1	100	100NHG1B-690	3	
	125	125NHG1B-690	3	
	160	160NHG1B-690	3	
	200	200NHG1B-690	3	
	50	50NHG1B-690	3	
	63	63NHG1B-690	3	
	80	80NHG1B-690	3	
2	63	63NHG2B-690	3	
	80	80NHG2B-690	3	
	100	100NHG2B-690	3	
	125	125NHG2B-690	3	
	160	160NHG2B-690	3	
	200	200NHG2B-690	3	
	224	224NHG2B-690	3	
	250	250NHG2B-690	3	
3	250	250NHG3B-690	3	
	315	315NHG3B-690	3	
	355	355NHG3B-690	3	
	400	400NHG3B-690	3	
	425	425NHG3B-690	3	
	500	500NHG3B-690	3	

400Vac

500Vac

690Vac

aM

Accessories

690Vac gG/gL - 2 to 125 Amps - Sizes 000 & 00

Time-Current Characteristics

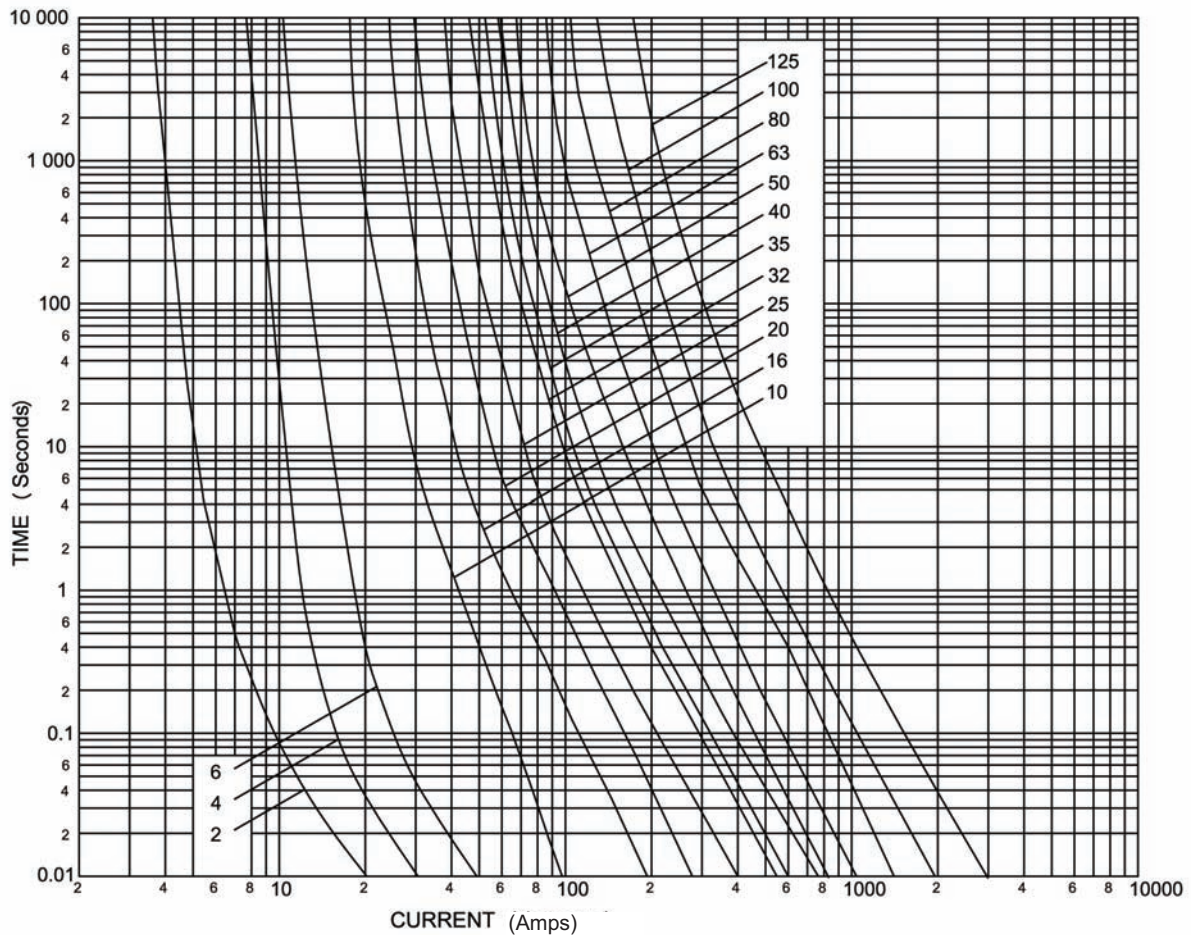

Technical Data

Part Numbers with Metal Gripping Lugs	Amp Rating	I^2t (Amps ² Seconds)		Watts Loss	Net Weight per Fuse
		Minimum Pre-arcing	* I_1 120kA @ 690Vac		
2NHG000B-690	2	3.5	8	4	0.133kg
4NHG000B-690	4	6	16	2	
6NHG000B-690	6	14	25	2	
10NHG000B-690	10	60	400	1.5	
16NHG000B-690	16	240	1200	2.5	
20NHG000B-690	20	500	2500	2.5	
25NHG000B-690	25	920	4400	3.5	
32NHG000B-690	32	1800	9600	3.5	
35NHG000B-690	35	2400	12700	4	
40NHG000B-690	40	3300	15000	4	
50NHG000B-690	50	3000	21000	5	0.200kg
63NHG000B-690	63	5500	38000	6	
80NHG000B-690	80	9800	67000	7	
100NHG000B-690	100	18000	119000	9.5	
125NHG000B-690	125	36000	210000	10.5	

* I_1 is the maximum breaking capacity test at rated voltage according to IEC 60269 requirements

400Vac

500Vac

690Vac

aM

Accessories

690Vac gG/gL - 6 to 100 Amps - Size 0

Time-Current Characteristics

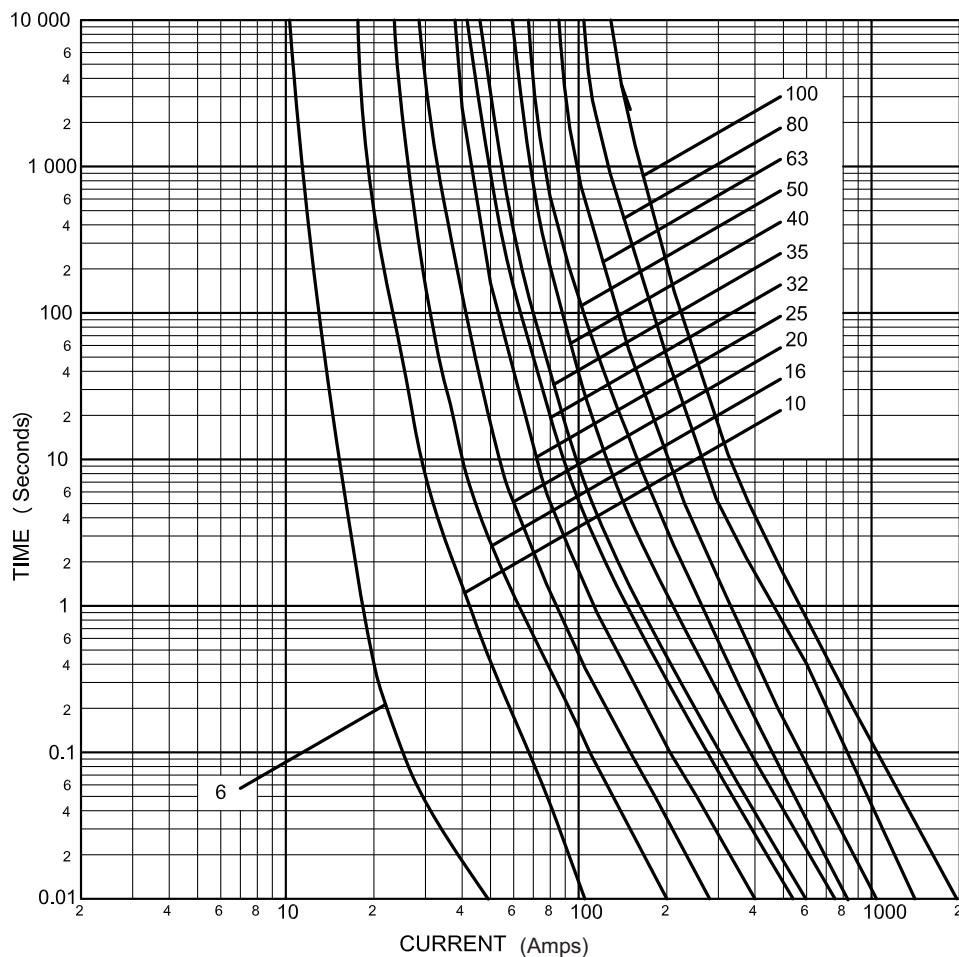

Technical Data

Part Numbers with Metal Gripping Lugs	Amp Rating	I ² t (Amps ² Seconds)		Watts Loss	Net Weight per Fuse
		Minimum Pre-arcing	*I ₁ 120kA		
6NHG0B-690	6	14	25	2	0.245kg
10NHG0B-690	10	58	430	2	
16NHG0B-690	16	240	1400	3	
20NHG0B-690	20	490	2800	3.5	
25NHG0B-690	25	1200	5400	3.2	
32NHG0B-690	32	1800	10800	4.8	
35NHG0B-690	35	2400	12700	4.7	
40NHG0B-690	40	3300	16500	5	
50NHG0B-690	50	3000	14700	6	
63NHG0B-690	63	5500	26000	7	
80NHG0B-690	80	9800	44000	8.5	
100NHG0B-690	100	18000	75000	9.5	

* I₁ is the maximum breaking capacity test at rated voltage according to IEC 60269 requirements

690Vac gG/gL - 50 to 200 Amps - Size 1

Time-Current Characteristics

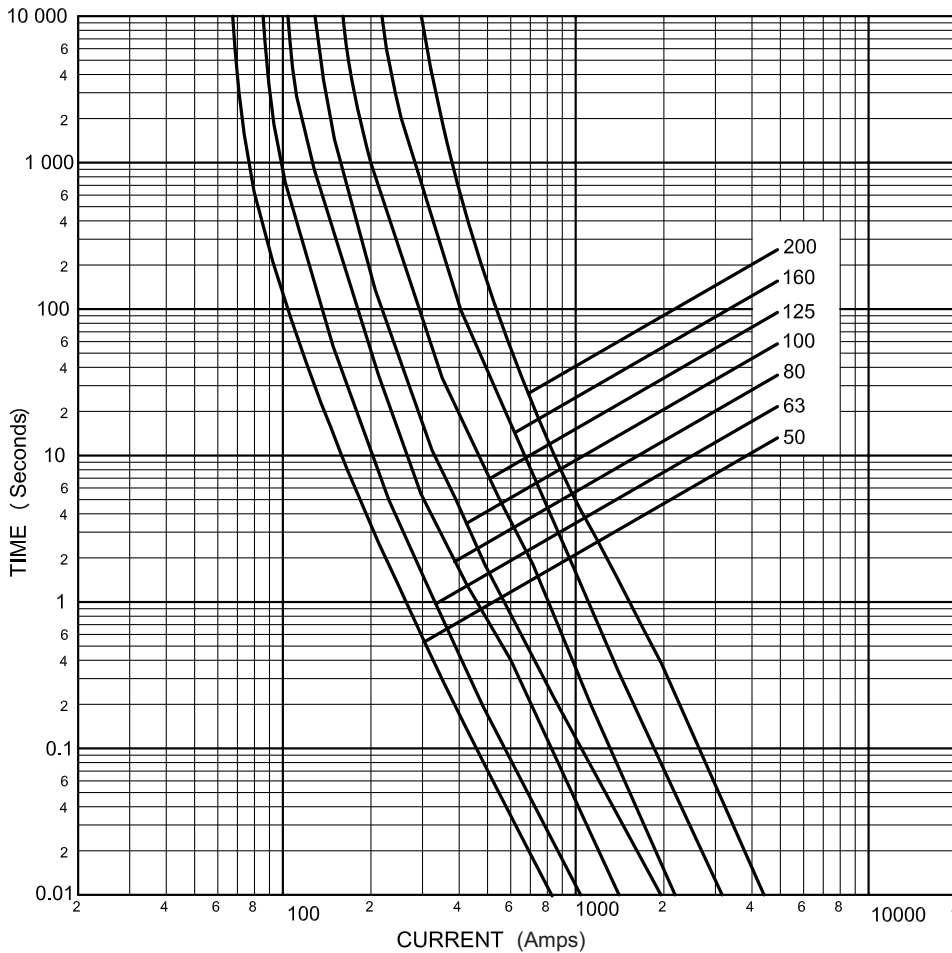

Technical Data

Part Numbers with Metal Gripping Lugs	Amp Rating	I ² t (Amps ² Seconds)		Watts Loss	Net Weight per Fuse
		Minimum Pre-arcing	*I ₁ 120kA @ 690Vac		
50NHG1B-690	50	3000	20000	6.0	0.409kg
63NHG1B-690	63	5500	38000	7.0	
80NHG1B-690	80	9800	71400	8.5	
100NHG1B-690	100	18000	136000	9.5	
125NHG1B-690	125	27000	98300	13.0	
160NHG1B-690	160	58000	195000	14.0	
200NHG1B-690	200	106000	328000	16.0	

* I₁ is the maximum breaking capacity test at rated voltage according to IEC 60269 requirements

400Vac

500Vac

690Vac

aM

Accessories

690Vac gG/gL - Size 2 - 63 to 315 Amps

Time-Current Characteristics

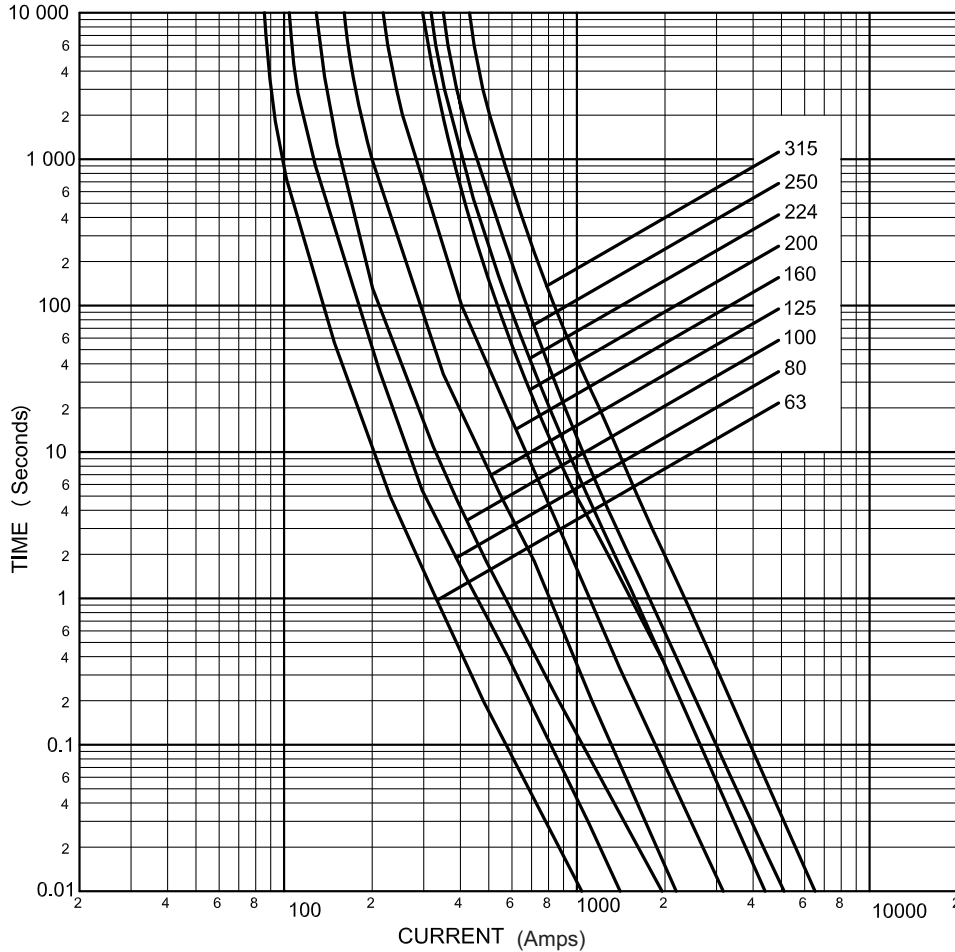

Technical Data

Part Numbers with Metal Gripping Lugs	Amp Rating	I ² t (Amps ² Seconds)		Watts Loss	Net Weight per Fuse
		Minimum Pre-arcing	*I ₁ 120kA @ 690Vac		
63NHG2B-690	63	5500	66300	7.5	0.647kg
80NHG2B-690	80	9800	112400	9	
100NHG2B-690	100	18000	193000	10	
125NHG2B-690	125	27000	112000	12.5	
160NHG2B-690	160	58000	207000	15	
200NHG2B-690	200	106000	328000	17.5	
224NHG2B-690	224	108000	355000	21	
250NHG2B-690	250	153000	625000	24	
315NHG2B-690	315	242000	788000	31	

* I₁ is the maximum breaking capacity test at rated voltage according to IEC 60269 requirements

690Vac gG/gL - 250 to 500 Amps - Size 3

Time-Current Characteristics

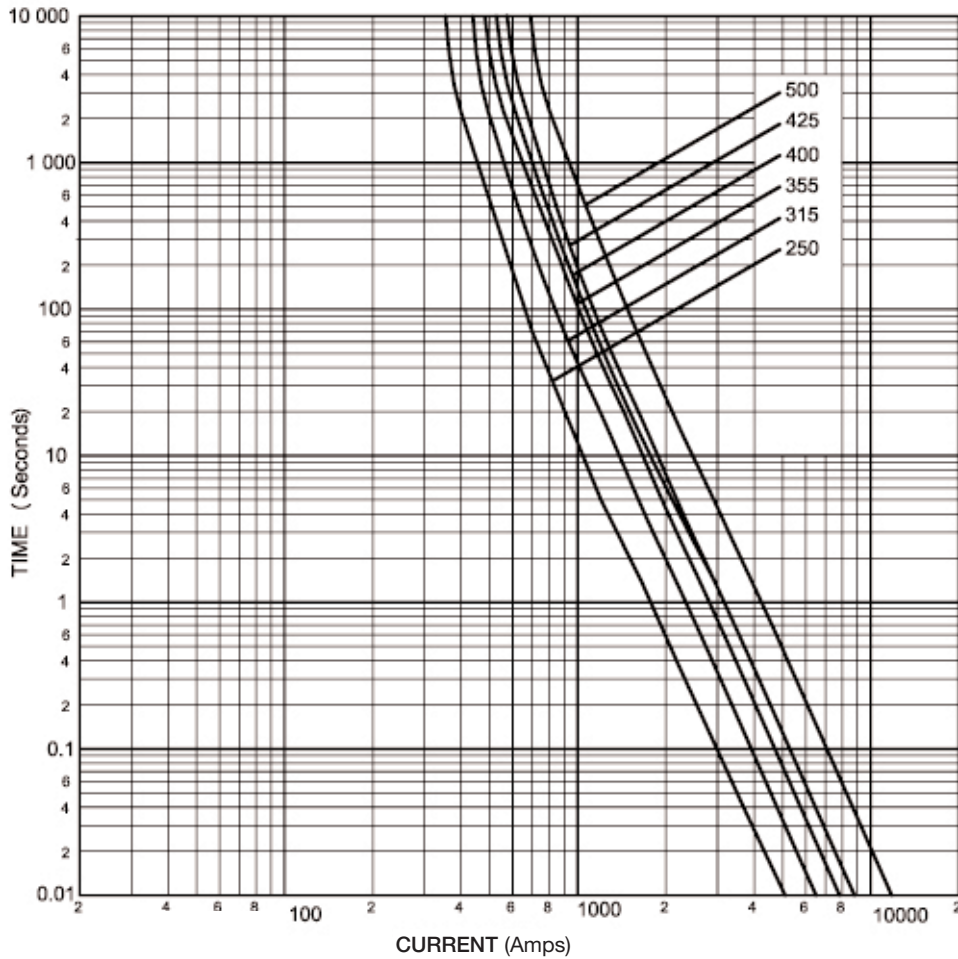

Technical Data

Part Numbers with Metal Gripping Lugs	Amp Rating	I ² t (Amps ² Seconds)		Watts Loss	Net Weight per Fuse
		Minimum Pre-arcing	*I ₁ 120kA @ 690Vac		
250NHG3B-690	250	153000	626000	23.0	1.113kg
315NHG3B-690	315	242000	798000	30.0	
355NHG3B-690	355	343000	130200	33.0	
400NHG3B-690	400	423000	1607000	38.0	
425NHG3B-690	425	430000	1418000	41.0	
500NHG3B-690	500	764000	2402000	45.0	

* I₁ is the maximum breaking capacity test at rated voltage according to IEC 60269 requirements

400Vac

500Vac

690Vac

aM

Accessories

690Vac gG/gL - 2 to 500 Amps - Sizes 000 to 3

Cut-Off Current Characteristics

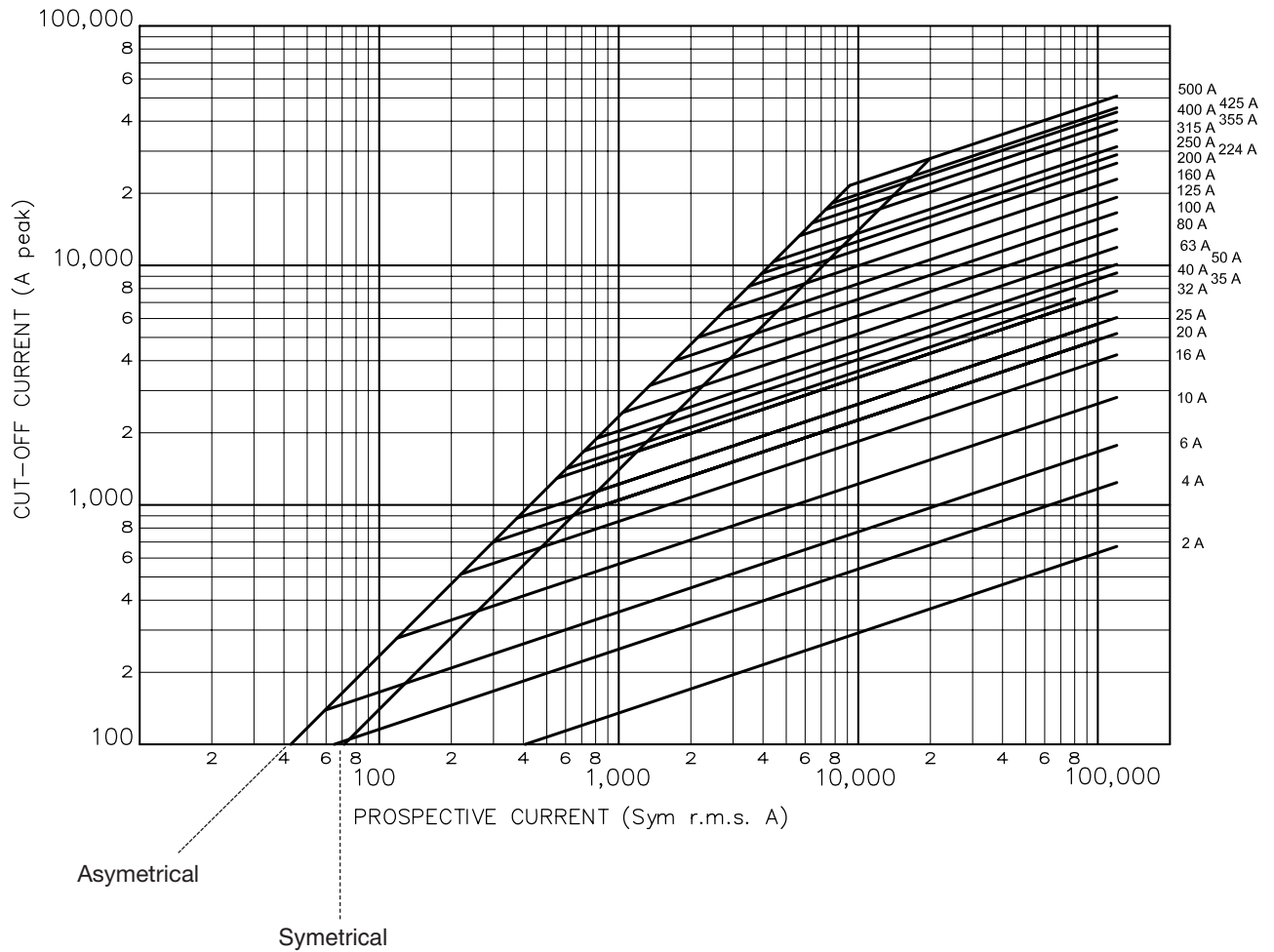

400Vac

500Vac

690Vac

aM

Accessories

500Vac & 690Vac aM - 6 to 630 Amps - Sizes 000 to 3



Description: A square bodied range of industrial fuse links for a wide variety of applications.

Part Number Structure: (amp)NHM(size)B & (amp)NHM(size)B-690 e.g. 50NHM00B and 125NHM2B-690

Class of Operation: aM

Standards/Approvals: IEC 60269, DIN 43620 and CE

Ratings:

- Volts: 500Vac and 690Vac
- Amps: 6 to 630A
- Breaking Capacity: 120kA AC
- Operating Frequency: 45-62Hz

Environmental:

- Recyclable
- RoHS compliant
- Lead and Cadmium free for sizes 000 to 3 (6 to 500A)

Packaging: All fuse links are packed in 3's.

Features:

- Energy savings
- Reliable dual indicator system
- Low temperature rise
- Globally compliant
- Intuitive part numbers

Microswitch for remote indication:

- BVL-50

400Vac

500Vac

690Vac

aM

Accessories

500Vac & 690Vac aM - 6 to 630 Amps - Sizes 000 to 3

Motor Protection Fuse Links - Part Numbers

Cooper Bussmann® aM fuse links have partial range breaking capacity and must be used in conjunction with a low overload protection device such as a motor protection relay.



400Vac

500Vac

690Vac

aM

Accessories

500 & 690Vac	Size	Rated Current (Amps)	aM Voltage Conducting Metal Gripping Lugs		Pack Quantity		
			500Vac	690Vac			
	000	6	-	6NHM000B-690	3		
		10	-	10NHM000B-690	3		
		16	-	16NHM000B-690	3		
		20	-	20NHM000B-690	3		
		25	-	25NHM000B-690	3		
		32	-	32NHM000B-690	3		
		35	-	35NHM000B-690	3		
		40	-	40NHM000B-690	3		
	00	50	50NHM00B	-	3		
		63	63NHM00B	-	3		
		80	80NHM00B	-	3		
		100	100NHM00B	-	3		
		160	160NHM00B	-	3		
	0	0	6	-	6NHM0B-690	3	
10			-	10NHM0B-690	3		
16			-	16NHM0B-690	3		
20			20NHM0B	-	3		
32			32NHM0B	-	3		
50			50NHM0B	-	3		
63			63NHM0B	-	3		
80			80NHM0B	-	3		
100		100NHM0B	-	3			
1		1	63	63NHM1B	-	3	
	80		80NHM1B	-	3		
	100		100NHM1B	-	3		
	125		125NHM1B	-	3		
	160		160NHM1B	160NHM1B-690	3		
	200		200NHM1B	-	3		
	250		250NHM1B	-	3		
2	2	125	-	125NHM2B-690	3		
		160	-	160NHM2B-690	3		
		200	-	200NHM2B-690	3		
		224	-	224NHM2B-690	3		
		250	-	250NHM2B-690	3		
		315	-	315NHM2B-690	3		
		355	-	355NHM2B-690	3		
		400	400NHM2B	-	3		
3	3	315	-	315NHM3B-690	3		
		355	-	355NHM3B-690	3		
		400	-	400NHM3B-690	3		
		500	-	500NHM3B-690	3		
		630	630NHM3B	-	3		
	0	6	-	6NHM0B-690	3		
		10	-	10NHM0B-690	3		
		16	-	16NHM0B-690	3		
		20	20NHM0B	-	3		
		32	32NHM0B	-	3		
		50	50NHM0B	-	3		
		63	63NHM0B	-	3		
		80	80NHM0B	-	3		
		100	100NHM0B	-	3		
		1	1	63	63NHM1B	-	3
				80	80NHM1B	-	3
				100	100NHM1B	-	3
				125	125NHM1B	-	3
				160	160NHM1B	160NHM1B-690	3
200	200NHM1B			-	3		
250	250NHM1B			-	3		
2	2	125	-	125NHM2B-690	3		
		160	-	160NHM2B-690	3		
		200	-	200NHM2B-690	3		
		224	-	224NHM2B-690	3		
		250	-	250NHM2B-690	3		
		315	-	315NHM2B-690	3		
		355	-	355NHM2B-690	3		
		400	400NHM2B	-	3		
3	3	315	-	315NHM3B-690	3		
		355	-	355NHM3B-690	3		
		400	-	400NHM3B-690	3		
		500	-	500NHM3B-690	3		
		630	630NHM3B	-	3		
	0	6	-	6NHM0B-690	3		
		10	-	10NHM0B-690	3		
		16	-	16NHM0B-690	3		
		20	20NHM0B	-	3		
		32	32NHM0B	-	3		
		50	50NHM0B	-	3		
		63	63NHM0B	-	3		
		80	80NHM0B	-	3		
		100	100NHM0B	-	3		
		1	1	63	63NHM1B	-	3
				80	80NHM1B	-	3
				100	100NHM1B	-	3
				125	125NHM1B	-	3
				160	160NHM1B	160NHM1B-690	3
200	200NHM1B			-	3		
250	250NHM1B			-	3		
2	2	125	-	125NHM2B-690	3		
		160	-	160NHM2B-690	3		
		200	-	200NHM2B-690	3		
		224	-	224NHM2B-690	3		
		250	-	250NHM2B-690	3		
		315	-	315NHM2B-690	3		
		355	-	355NHM2B-690	3		
		400	400NHM2B	-	3		
3	3	315	-	315NHM3B-690	3		
		355	-	355NHM3B-690	3		
		400	-	400NHM3B-690	3		
		500	-	500NHM3B-690	3		
		630	630NHM3B	-	3		

500Vac & 690Vac aM - 6 to 630 Amps - Sizes 000 to 3

Time-Current Characteristics

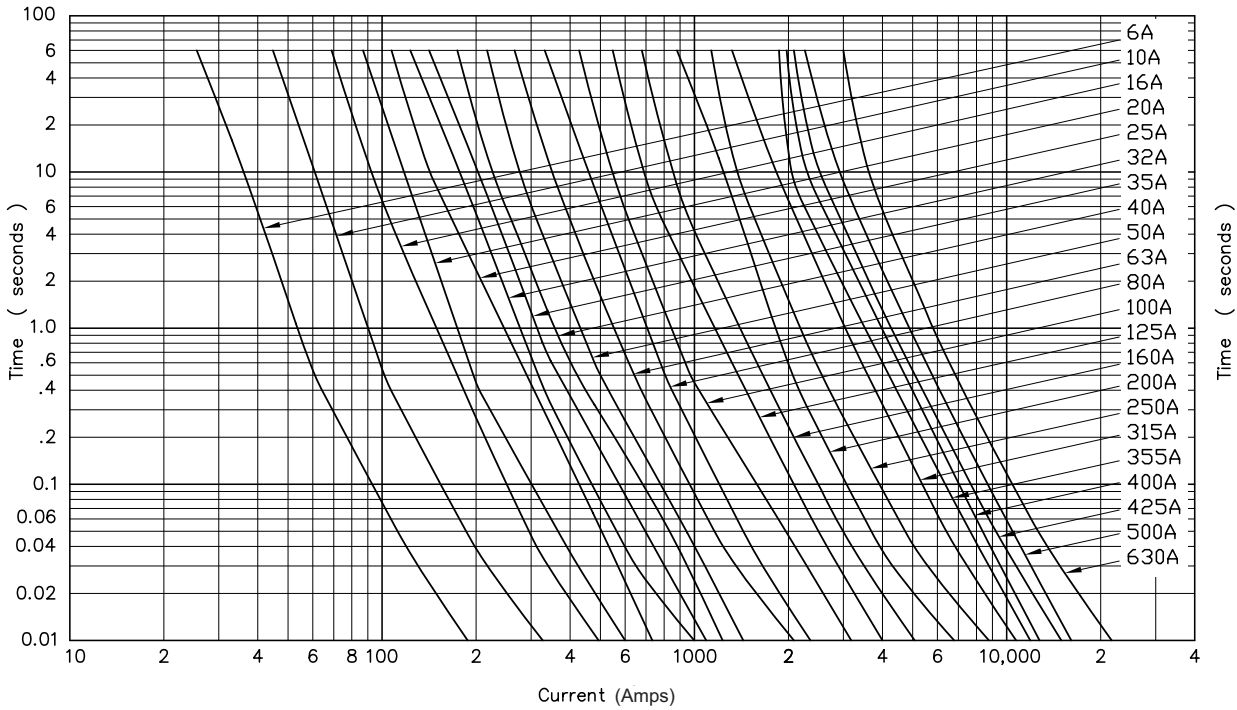

400Vac

500Vac

690Vac

aM

Accessories

500Vac & 690Vac aM - 6 to 630 Amps - Sizes 000 to 3

Cut-Off Current Characteristics

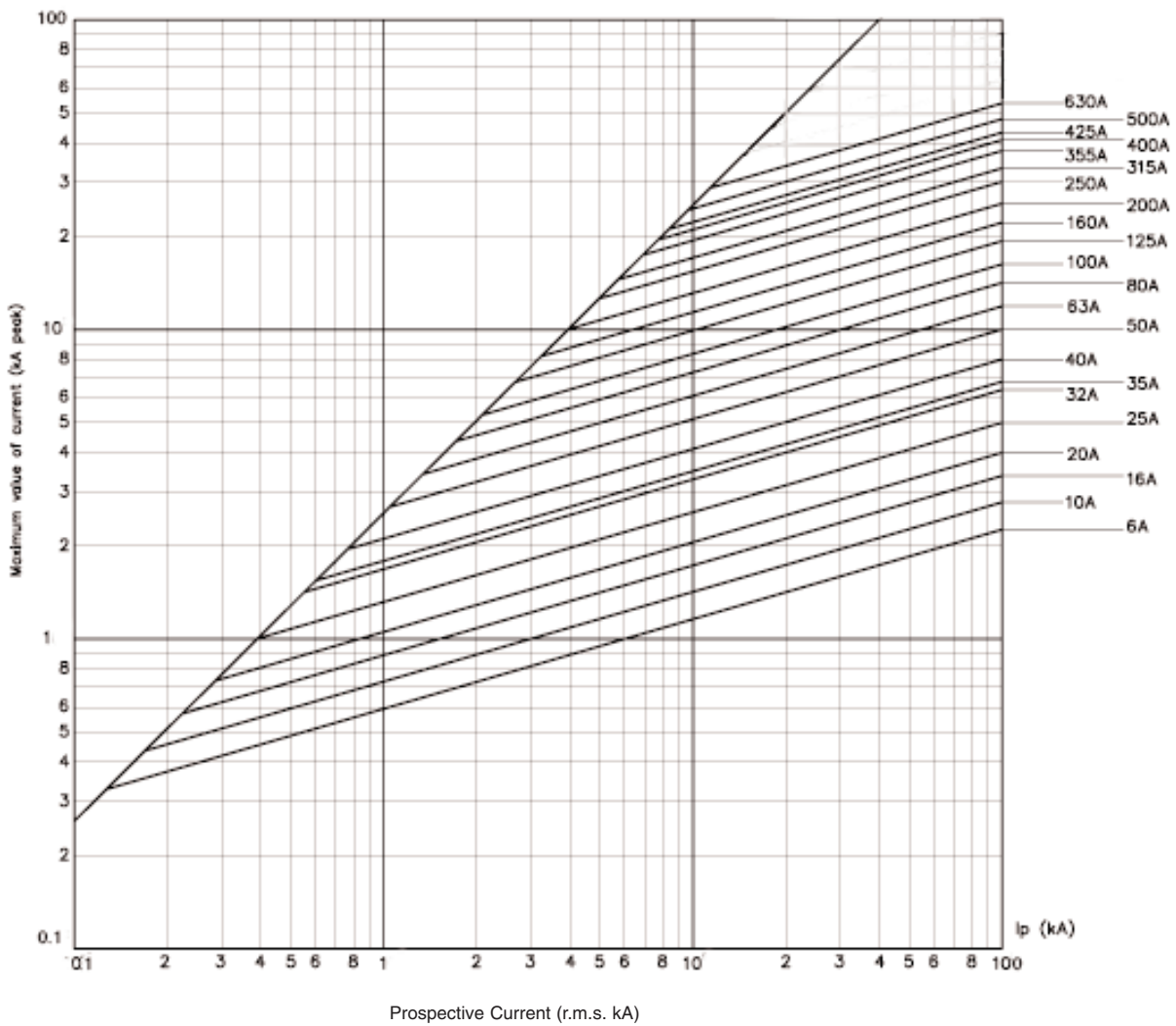

500Vac & 690Vac aM - 6 to 630 Amps - Sizes 000 to 3

Technical Data

Part Numbers	Fuse Size	Amp Rating	I ² t Pre-arcing	Total Clearing at 500V	Total Clearing at 690V	Watts Loss	Net Weight per Fuse
6NHM000B-690	000	6	71	-	360	0.33	0.133kg
10NHM000B-690		10	175	-	700	0.52	
16NHM000B-690		16	520	-	2000	0.81	
20NHM000B-690		20	790	-	3000	0.92	
25NHM000B-690		25	1000	-	4000	1.08	
32NHM000B-690		32	1700	-	6800	1.42	
35NHM000B-690		35	2450	-	9100	1.58	
40NHM000B-690		40	3500	-	13500	1.68	
50NHM00B	00	50	5000	14000	-	2.28	0.200kg
63NHM00B		63	8800	24000	-	2.90	
80NHM00B		80	10500	30100	-	4.19	
100NHM00B		100	17000	49000	-	5.09	
160NHM00B		160	38000	100000	-	7.73	
6NHM0B-690	0	6	71	-	360	0.42	0.245kg
10NHM0B-690		10	175	-	700	0.67	
16NHM0B-690		16	520	-	2000	0.98	
20NHM0B		20	790	2100	-	1.04	
32NHM0B		32	1750	4900	-	1.67	
50NHM0B		50	5000	14000	-	2.51	
63NHM0B		63	8800	24000	-	3.35	
80NHM0B		80	10500	30100	-	4.93	
100NHM0B		100	17000	49000	-	5.72	
63NHM1B		1	63	8800	24000	-	
80NHM1B	80		10500	30100	-	4.60	
100NHM1B	100		17000	49000	-	5.70	
125NHM1B	125		25000	70000	-	6.98	
160NHM1B	160		38000	100000	-	9.20	
200NHM1B	200		51000	150000	-	13.70	
250NHM1B	250		79000	210000	-	15.30	
125NHM2B-690	2	125	25000	-	96000	7.60	0.647kg
160NHM2B-690		160	38000	-	145000	9.70	
200NHM2B-690		200	51000	-	200000	13.90	
250NHM2B-690		250	79000	-	300000	17.00	
315NHM2B-690		315	115000	-	450000	26.00	
355NHM2B-690		355	165000	-	650000	25.20	
400NHM2B		400	250000	710000	-	29.30	
315NHM3B-690	3	315	110000	-	450000	20.60	1.113kg
355NHM3B-690		355	160000	-	650000	23.90	
400NHM3B-690		400	250000	-	980000	26.50	
500NHM3B-690		500	550000	-	2000000	35.80	
630NHM3B		630	800000	2300000	-	56.90	

400Vac

500Vac

690Vac

aM

Accessories

NH Fuse Bases

SB*-D, SB*-S

Up to 690V / 160 - 1250A
Sizes 00, 0, 1, 2, 3, 4



Description: NH fuse bases with thermoplastic bodies. DIN rail and screw mounting (size 4 screw fix). Range of protection accessories for live parts in order to obtain IP20 protection standard.

Ratings:

- Voltage: up to 690Vac
- Amps: 2 to 1250A

Applications: Protection of industrial circuits and electrical apparatus

Standards and Approvals: IEC 60269, DIN 43620

Technical Data: see page 43

Dimensions: see page 43 and 44

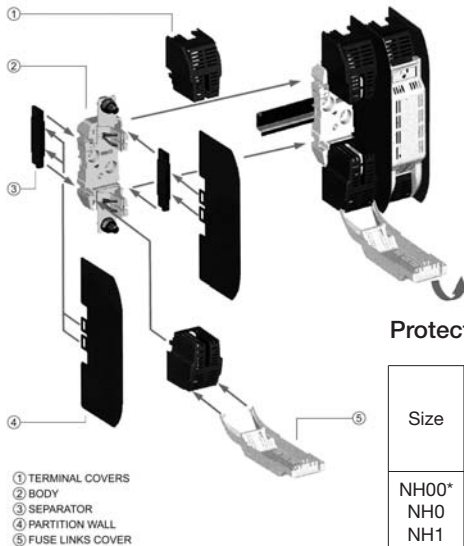

- ① TERMINAL COVERS
- ② BODY
- ③ SEPARATOR
- ④ PARTITION WALL
- ⑤ FUSE LINKS COVER

Protection accessories

Size	Current (Amps)	Separation Partition ④		Fuse Casing ⑤		Terminal Cover ①		Separator ③	
		Part Ref	Unit Packing	Part Ref	Unit Packing	Part Ref	Unit Packing	Part Ref	Unit Packing
NH00*	160A	SP00*	2	FC00*	3	CS00*	6	BC00*	2
NH0	160A	SP0	2	FC0	3	CS0	6	BC0	2
NH1	250A	SP1-2	2	FC1-2	3	CS1	6	BC1-2	2
NH2	400A	SP1-2	2	FC1-2	3	CS2	6	BC1-2	2
NH3	630A	SP3	2	FC3	3	CS3	6	BC3	2

* For single pole only

IP Protection Kits

Part Reference	Description
TB00-D-IP20	Complete triple pole fuse base IP20 rated
FPK0-3P	IP20 kit for TB0-D fuse base
FPK1-3P	IP20 kit for TB1-D fuse base
FPK2-3P	IP20 kit for TB2-D fuse base
FPK3-3P	IP20 kit for TB3-D fuse base

Part Numbers

Size	Poles	Current (Amps)	Part Numbers	Unit Packing	Compatible Fuse Link Size
			DIN Screw		
00	1 3	160A	SB00-D TB00-D TB00-D-IP20	3 1	000 & 00
0	1 3	160A	SB0-D TB0-D	3 1	0
1	1 3	250A	SB1-D TB1-D	3 1	01 & 1
2	1 3	400A	SB2-D TB2-D	3 1	02 & 2
3	1 3	630A	SB3-D TB3-D	3 1	03 & 3
4	1	1250A	SB4-S (Screw Connection only)	3	4

Neutral

Size	Current (Amps)	Part Ref	Unit Packing
NH00	160	SL00	3
NH0	160	SL0	
NH1	250	SL1	
NH2	400	SL2	
NH3	630	SL3	
NH4	1000	SL4	



Fuse extraction handle

Size	Part Ref	Unit Packing
C00-3	FEH	1
C00-3	FEH-S*	1

* with glove



Microswitch

Part Ref	Unit Packing
BVL-50	1



Microswitch suitable for the following NH Fuse links:

- 400 Volts gG/gL
- 500 Volts gG/gL and aM
- 690 Volts gG/gL and aM

NH Fuse Bases - Technical Data

Technical Data		SB00-D/ TB00-D	SB0-D/ TB0-D	SB1-D/ TB1-D	SB2-D/ TB2-D	SB3-D/ TB3-D	SB4-S
Body		Polyamide +25%F.V. UL94-V0					N/A
Contacts		Silver plated					
Screw, Nuts and Washers		High quality steel					
Derating Temperature Factors	20°C	1	1	1	1	1	1
	30°C	0.95	0.95	0.95	0.95	0.95	0.95
	40°C	0.9	0.9	0.9	0.9	0.9	0.9
	50°C	0.8	0.8	0.8	0.8	0.8	0.8
Maximum Power Dissipation		12W	25W	32W	45W	60W	90W
Degree of Protection		IP00/IP20	IP00/IP20	IP00/IP20	IP00/IP20	IP00/IP20	IP00
Connecting	Screw	M8	M8	M10	M12	M12	M16
	Clamp	2xM6					
Maximum Tightening Torque	Screw	10N•m	10N•m	32N•m	32N•m	32N•m	56N•m
	Clamp	4N•m					
Fixing	Rail Din	•	•	•	•	•	•
	Screw	•	•	•	•	•	•
With Microswitch 16A/250V	Presence-Fusion	-	•	•	•	•	•
Function Temperature		-20 -70°C	-20 -70°C	-20 -70°C	-20 -70°C	-20 -70°C	-20 -70°C
Storage Temperature		-40 -80°C	-40 -80°C	-40 -80°C	-40 -80°C	-40 -80°C	-40 -80°C

NH Fuse Bases Dimensions (mm)

NH Fuse Bases Size 00

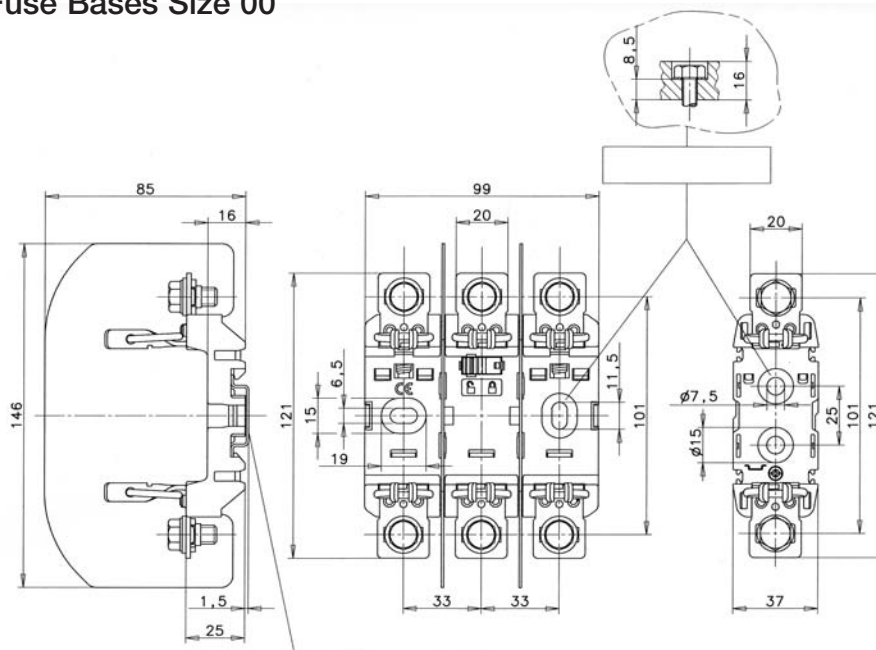

400Vac

500Vac

690Vac

aM

Accessories

NH Fuse Bases Dimensions (mm)

NH Fuse Bases Sizes 0, 1, 2, 3

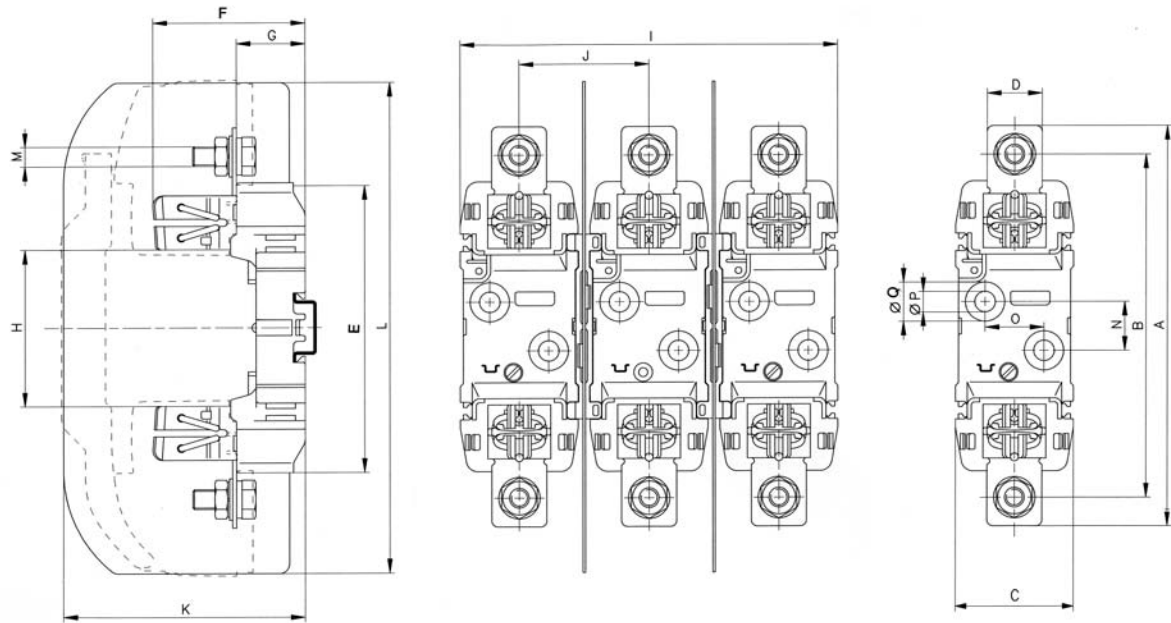

Size	A	B	C	D	E	F	G	H	I	J	K	L	M	N	O	P	Q
NH0	170	150	47	24	122	63	29	74	144	48.5	91.5	185	M8	25	-	7.5	15
NH1	200	175	60	28	148	77.5	35	80	192	66	123	250	M10	25	30	10.5	20.5
NH2	225	200	60	32	148	88	35	80	192	66	123	250	M12	25	30	10.5	20.5
NH3	240	210	60	38	148	97	35	80	224	82	143	270	M12	25	30	10.5	20.5

NH Fuse Bases size 4

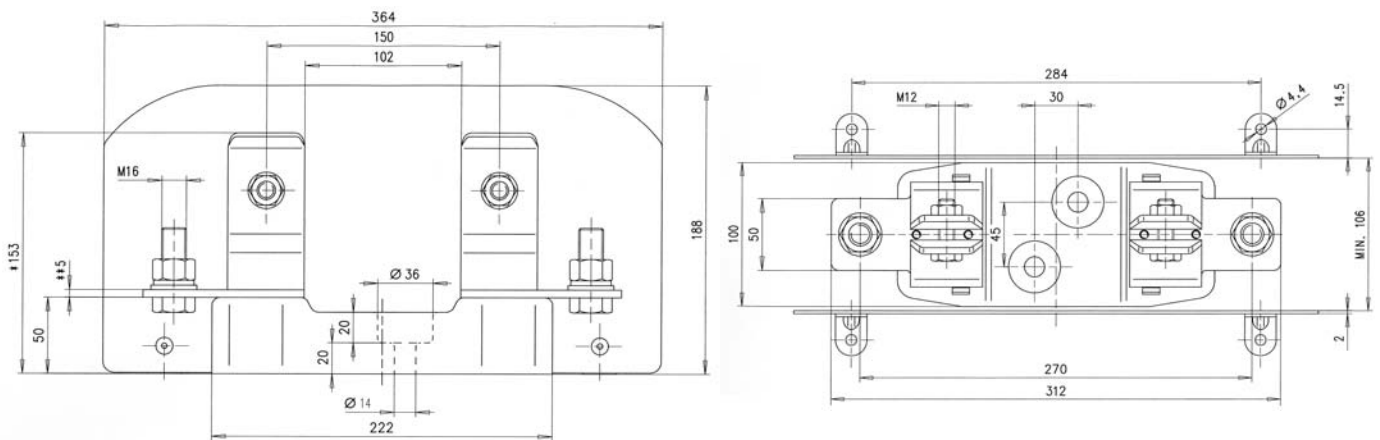

NH Fuse Rails - Vertical

BFR
690V / 160 - 630A
Sizes 00, 1, 2, 3

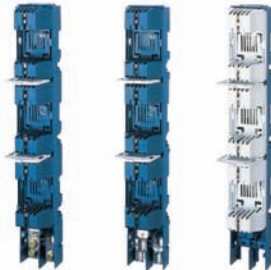

Description: Vertical fus used with NH fuse links. Fully protected against accidental contact..

Main features are:

- Contact covers
- Phase barriers
- Label for protected circuit identification
- Busbar mounting option

Ratings:

- Volts: 690Vac
- Amps: 160 to 630A

Applications: Disconnecting cabinets and low voltage distribution switchboards with busbar spacing of 185mm

Standards and Approvals: CE, IEC 60269, EN 354701

Dimensions: see page 46

Technical Data:

Type		BL00-3-F-HA	BFR1	BFR2	BFR3
Rated Current	I_n	160A	250A	400A	630A
Standards		IEC 60269-1, 2	IEC 60269-1, 2-1	IEC 60269-1, 2-1 EN 354701-2-1	IEC 60269-1, 2-1 EN 354701-2-1
Rated Voltage	U_n	690Vac	690Vac	690Vac	690Vac
Rated Frequency	f	40-60Hz	40-60Hz	40-60Hz	40-60Hz
Rated Insulation Voltage	U_i	750Vac	1000Vac	1000Vac	1000Vac
Fuse Link Size		000, 00	1	2	3
Max Rated Current of the Fuse Link	I_n	160A	250A	400A	630A
Thermal Current/Maximum Cable Size	I_{th}	210A with disconnecting knife SL00/Cross-section	400A/240mm ² with disconnection knife SL1/Cross-section	560A/183mm ² with disconnection knife SL2/Cross-section	800A/2x185mm ² with disconnection knife SL3/Cross-section
Degree of Protection		IP20	IP20	IP20	IP20
Max Power Losses of the Fuse Link	P_y	12W	32W	45W	60W
Permissible Ambient Temperature		-25°C to 55°C	-25°C to 55°C	-25°C to 55°C	-25°C to 55°C

Part Numbers

Size	Rating (Amps)	Part Reference	Leading out Terminals	Compatible Fuse Links Size
00	160	BL00-3-F-HA	M8 cable connections	000 & 00
1	250	BFR1-3K/LM/C (*)	Pressed-in nuts with M10 screw	01 & 1
		BFR1-3K/LW	V-shaped clamps	
		BFR1-3K/LL	Busbar systems 185mm Busbar spacing connects to Busbar with M12 bolts	
2	400	BFR2-3K/LM/C (*)	Pressed-in nuts with M10 screw	02 & 2
		BFR2-3K/LW	V-shaped clamps	
		BFR2/3K/LL	Busbar systems 185mm Busbar spacing connects to Busbar with M12 bolts	
3	630	BFR3-3K/LM/C (*)	Pressed-in nuts with M10 screw	03 & 3
		BFR3-3K/LW	V-shaped clamps	
		BFR3-3K/LL	Busbar systems 185mm Busbar spacing connects to Busbar with M12 bolts	

* with leading-out terminal cover

400Vac

500Vac

690Vac

aM

Accessories

NH Fuse Rails - Vertical - Dimensions (mm)

Dimensions for BL00-3-F-HA

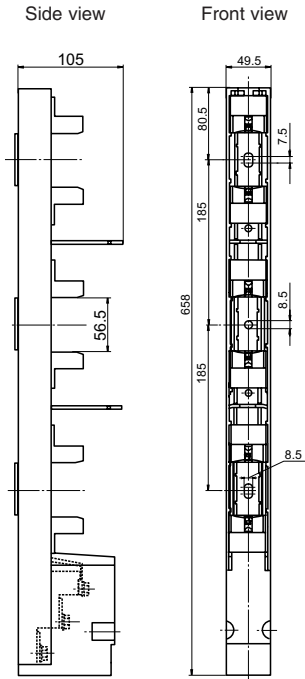

Dimensions for BFR1, BFR2 and BFR3

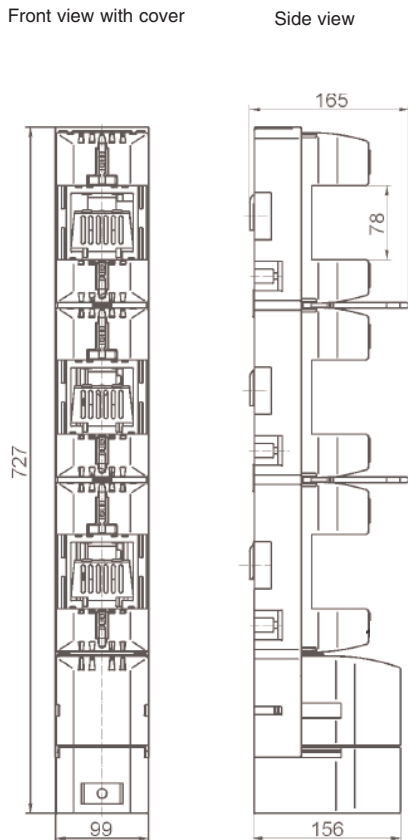

Dimensions for BFR1, BFR2 and BFR3

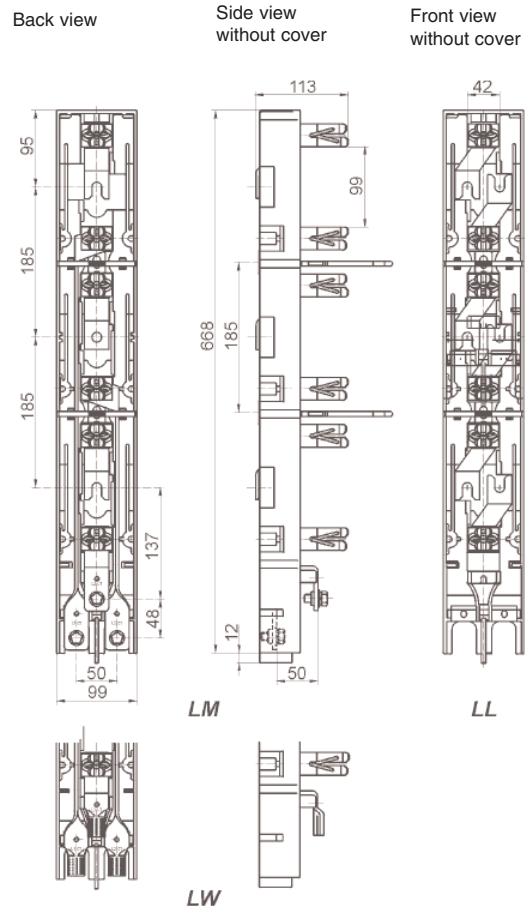

400Vac

500Vac

690Vac

aM

Accessories

NH Fuse Switch Disconnectors - Vertical

BFD
690V / 160 - 630A
Sizes 00, 1, 2, 3



Description: Vertical fuse switch disconnectors are designed to be used with NH fuse links. Enabling safe connection and disconnection on the load.

Main features are:

- Lockable fuse cover
- Label for circuit identification
- Busbar mounting

Ratings:

- Volts: 690Vac
- Amps: 160 - 630A
- Utilization category: 400Vac - AC23B / 690Vac - AC22B

Applications: Distribution and industrial switchboards with busbar spacing of 185mm.

Standards and Approvals: CE, IEC 60947

Technical Data: see page 48

Dimensions: see page 48

Part Numbers

Size	Rating (Amps)	Part Reference		Terminals	Unit Packing	Compatible Fuse Links Size
		1-Pole Switching	3-Pole Switching			
00	160A	N/A	BSL00-3x-F	M8 cable connections	1	00
1	250	BFD1-31/LM	BFD1-33/LM	Pressed-in nuts with M10 screw	1	01 & 1
		BFD1-31/LW	BFD1-33/LW	V-shaped clamps	1	
		BFD1-31/LL	BFD1-33/LL	Switch disconnectors for Busbar systems 185mm Busbar spacing connects to Busbar with M12 bolts	1	
2	400	BFD2-31/LM	BFD2-33/LW	Pressed-in nuts with M10 screw	1	02 & 2
		BFD2-31/LW	BFD2-33/LW	V-shaped clamps	1	
		BFD2-31/LL	BFD2-33/LL	Switch disconnectors for Busbar systems 185mm Busbar spacing connects to Busbar with M12 bolts	1	
3	630	BFD3-31/LM	BFD3-33/LM	Pressed-in nuts with M12 screw	1	03 & 3
		BFD3-31/LW	BFD3-33/LW	V-shaped clamps	1	
		BFD3-31/LL	BFD3-33/LL	Switch disconnectors for Busbar systems 185mm Busbar spacing connects to Busbar with M12 bolts	1	

400Vac

500Vac

690Vac

aM

Accessories

NH Fuse Switch Disconnectors - Vertical - Technical Data

Type		BSL00-3x-F	BFD1	BFD2	BFD3
Rated Current	I_n	160A	250A	400A	630A
Rated Voltage	U_n	750Vac	690Vac	690Vac	690Vac
Standards		IEC 60947-1-3, EN 60947-1-3	IEC 60947-1-3, EN 60947-1-3	IEC 60947-1-3, EN 60947-1-3	IEC 60947-1-3, EN 60947-1-3
Utilisation Category	U_n	AC20B at 400Vac	AC23B at 400Vac/AC22B at 690Vac	AC23B at 400Vac/AC22B at 690Vac	AC23B at 400Vac/AC22B at 690Vac
Thermal Current with Fuse Links	I_{th}	160A	250A	400A	630A
Thermal Current with Fuse Links (with disconnecting knife)	I_{th}	160A with disconnecting knife SL00	400A with disconnecting knife SL1	560A with disconnecting knife SL2	800A with disconnecting knife SL3
Rated Frequency	f	40-60Hz	40-60Hz	40-60Hz	40-60Hz
Rated Insulation Voltage	I_{kn}	750Vac	1000Vac	1000Vac	1000Vac
Conditional Short-Circuit Current with Fuse Links PN (RMS)		50kA	120kA	120kA - up to 250A 80kA - up to 400A	120kA - up to 250A 80kA - up to 400A 50kA - up to 630A
Impulse Withstand Voltage	U_{im}	6kV	8kV	8kV	8kV
Fuse Link Size		000, 00	1	2	3
Max Rated Current of the Fuse Link	I_n	160A	250A	400A	630A
Max Power Loss of the Fuse Link		12W	23W	34W	48W
Power Losses at I_n without Fuse Link	I_n	20W	18W	39W	90W
Electrical Durability	P_v	200	200	200	200
Mechanical Durability	P_v	1400	1400	800	800
Degree of Protection from Front Side, Built in Device, Cover Closed		IP20	IP20	IP20	IP20
Degree of Protection from Front Side, Built-in Device, Cover Opened		IP20	IP20	IP20	IP20
Permissible Ambient Temperature		-25°C to 55°C	-25°C to 55°C	-25°C to 55°C	-25°C to 55°C
Altitude Above Sea Level		max 2000m	max 2000m	max 2000m	max 2000m
Overvoltage Category for 690Vac		III	III	III	III
Seismic Resistance acc to VDE SKODA		1.5g/8 to 50Hz	1.5g/8 to 50Hz	1.5g/8 to 50Hz	1.5g/8 to 50Hz

NH Fuse Switch Disconnectors - Vertical - Dimensions (mm)

Dimensions for BSL00-3x-F

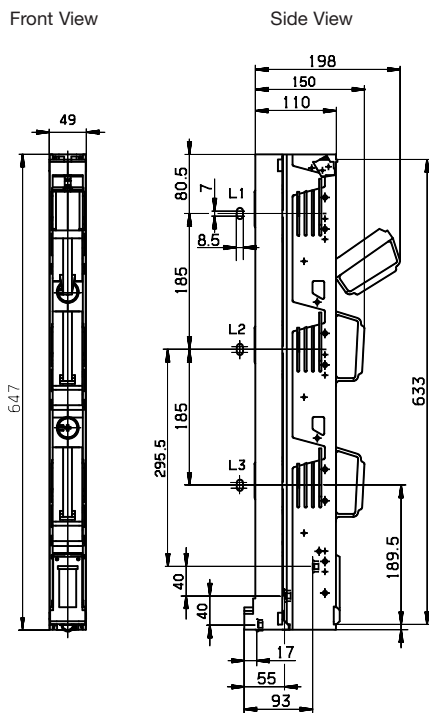

Dimensions for BFD1, BFD2 and BFD3

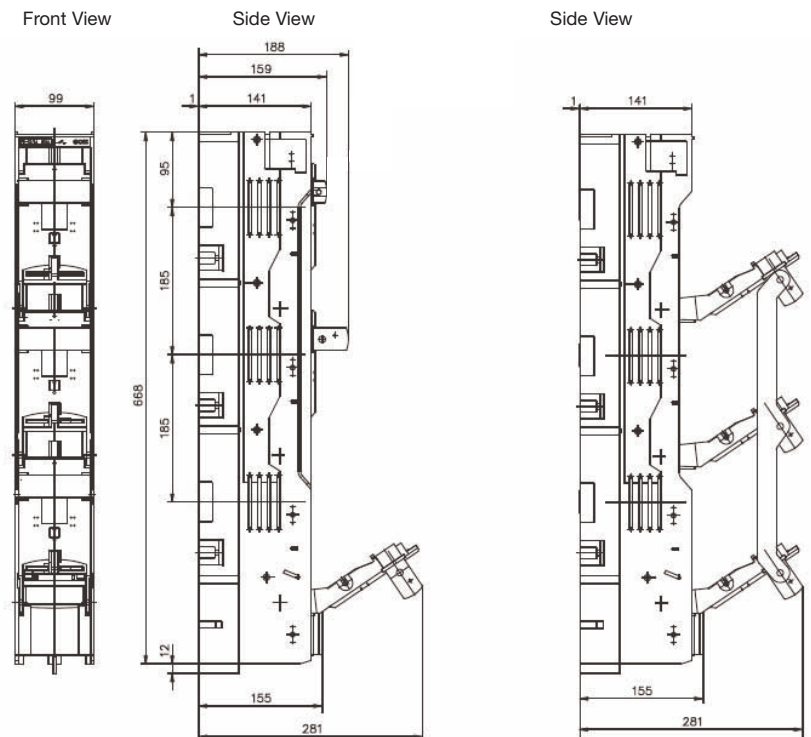

NH Fuse Switch Disconnectors - Horizontal

BFH
690V / 160 - 1600A
Sizes 000, 00, 1, 2, 3, 4



Description: Horizontal switch disconnectors are designed to be used with NH fuse links. Enabling safe connection and disconnection on load.

Main features are:

- Lockable fuse cover
- Label for protected circuit identification
- Panel mounting with screws (size 000 can be DIN railed mounted). Busbar mounting with screws.

Ratings:

- Volts: 690Vac / 250Vdc (sizes 1,2,3)
 400Vdc (size 000)
- Amps: 160 -1600A
- Utilisation category: 400Vac - AC23B
 500Vac - AC22B
 690Vac - AC21B
 250Vdc - DC21B (sizes 1,2,3)
 250Vdc - DC22B (sizes 000,00)

Applications: Industrial control panels, motor control panels

Standards and Approvals: CE, IEC 60947

Technical Data: see page 50

Dimensions: see page 51 to 53

Part Numbers

Size	Rating (A)	Catalogue Number		Terminals	Unit Packing	Compatible Fuse Links Size
		1- Pole	3-Pole			
000	160	BFH000-1A/T	BFH000-3A/T	Terminal clips for 1.5 to 50mm ² cable	1	000
00	160	BFH00-1A/F	BFH00-3A/F	Terminal screw M8	1	00
1	250	BFH1-1A/F	BFH1-3A/F	Terminal screws M10	1	01 & 1
2	400	BFH2-1A/F	BFH2-3A/F	Terminal screws M10	1	02 & 2
3	630	BFH3-1A/F	BFH3-3A/F	Terminal screws M12	1	03 & 3
4	1600	LBS4/1	LBS4/3	Terminal screws 2xM12	1	4

400Vac

500Vac

690Vac

aM

Accessories

NH Fuse Switch Disconnectors- Horizontal - Technical Data

Type		BFH000/BF00	BFH1	BFH2	BFH3
Rated Voltage	U_n	690Vac	690Vac/250Vdc	690Vac/250Vdc	690Vac/250Vdc
Rated Current	I_n	160A	250A	400A	630A
Utilisation Category		AC20B at 400Vac AC22B at 500Vac AC21B at 690Vac DC22B at 250Vdc DC20B at 440Vdc	AC23B at 400Vac AC22B at 500Vac AC21B at 690Vac AC22B at 690Vac/200A DC21B at 250Vdc	AC23B at 500Vac for BFH2-3 AC23B at 400Vac for BFH2-1 AC22B at 690Vac DC21B at 250Vdc	AC23B at 500Vac for BFH3/F AC23B at 400Vac for BFH3-1/F AC22B at 690Vac DC21B at 250Vdc
Thermal Current with Fuse links	I_{th}	160A	250A	400A	630A
Thermal Current with Fuse Links with Disconnecting Knife			325A with disconnecting knife SL1	520A with disconnecting knife SL2	750A with disconnecting knife SL3
Rated Frequency	f	40-60Hz	40-60Hz	40-60Hz	40-60Hz
Rated Insulation Voltage	U_i	800Vac	1000Vac	1000Vac	1000Vac
Conditional Short Circuit Current (RMS)	I_{kn}	120kA for 400Vac/160A 120kA for 500Vac/100A 80kA for 690Vac/100A	120kA for 400Vac/250A 50kA for 500Vac/250A min 25kA for 690Vac/250A	120kA for 400Vac/250A 50kA for 500Vac/250A min 25kA for 690Vac/250A	120kA for 400Vac/630A 50kA for 500Vac/630A min 25kA for 690Vac/630A
Impulse Withstand Voltage	U_{imp}	8kV for BFH000-AV	12kV for BFH1-A/F	12kV for BFH2-A/F	12kV for BFH3-A/F
Fuse Link Size		0	1	2	3
Max Power Losses of the Fuse Link	P_V	9W	23W	34W	48W
Power Losses at I_n Without Fuse Link	P_V	7W	9W	23W	49W
Electrical Durability (operating cycle)		300 at 100A 200 at 160A	200 at 250A	200 at 400A	200 at 630A
Mechanical Durability (operating cycle)		2000	1400	800	800
Degree of Protection from Front Side, Built-In Device, Cover Closed (measuring holes filled)		IP30	IP30	IP30	IP30
Degree of Protection from Front Side, Built-In Device, Cover Opened		IP20	IP20	IP20	IP20
Permissible Ambient Temperature		-25°C to 55°C	-25°C to 55°C	-25°C to 55°C	-25°C to 55°C
Altitude Above Sea Level		max 2000m	max 2000m	max 2000m	max 2000m
Pollution Degree		3	3	3	3
Overvoltage Category for 690Vac		III	IV	IV	IV
Seismic Resistance		0.25 to 50Hz/3g	0.25 to 50Hz/3g	0.25 to 50Hz/3g	0.25 to 50Hz/3g
Torque of Outlets Terminals		3 to 3.5Nm			
Standards		IEC 60947-1, 3 IEC 60947-1,3	IEC 60947-1,3 IEC 60947-1,3	IEC 60947-1,3 IEC 60947-1,3	IEC 60947-1,3 IEC 60947-1,3

400Vac

500Vac

690Vac

aM

Accessories

NH Fuse Switch Disconnectors - Horizontal - Dimensions (mm)

Size 000

BHF000-1A/T & BFH000-3A/T
side view

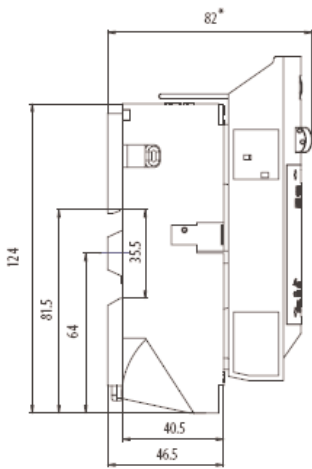

BHF000- 1A/T & BFH000-3A/T
in open position

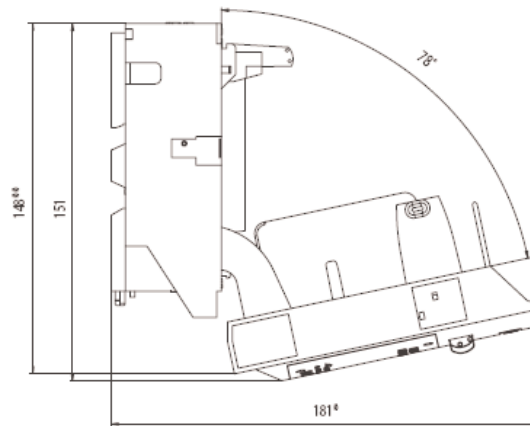

Clearance and drilling plans for
BHF000-1A/T (1 pole), for BHF000-3A/T
(3 poles) multiply the width by 3

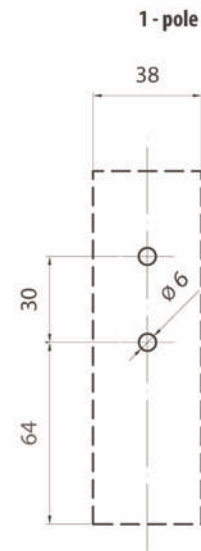

Size 00

BFH00-1A/F and BFH00-3A/F
side view

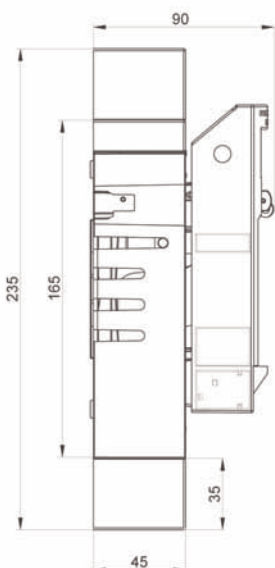

BFH00-1A/F and BFH00-3A/F
in open position

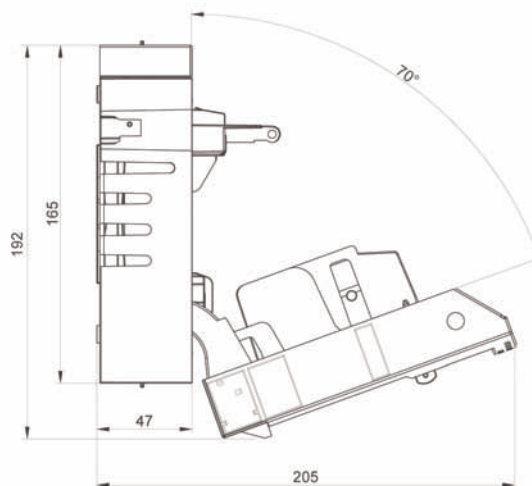

Clearance and drilling plans for
BHF00-1A/F (1 pole), for BHF00-3A/F
(3 poles) multiply the width by 3



400Vac

500Vac

690Vac

aM

Accessories

NH Fuse Switch Disconnectors - Horizontal - Dimensions (mm)

Size 1

BH1-1A/F and BH1-3A/F
side view

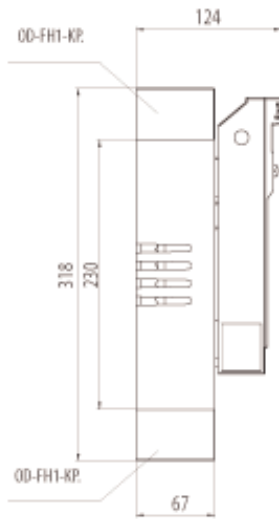

BH1-1A/F and BH1-3A/F
in open position

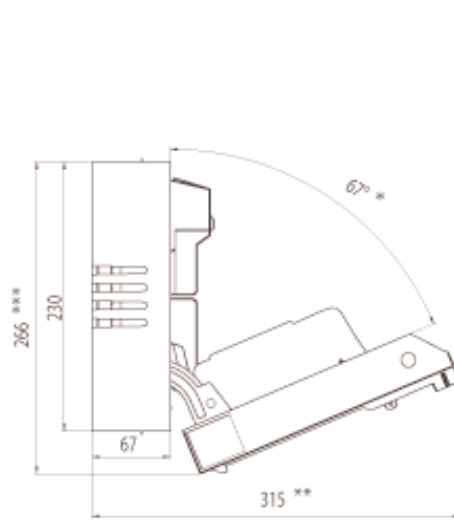

Clearance and drilling plans for
BHF1-1A/F (1 pole), for BHF1-3A/F
(3 poles) multiply the width by 3

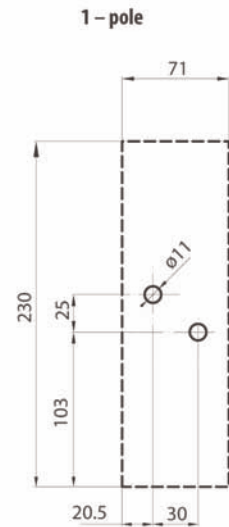

Size 2

BFH2-1A/ and BFH2-3A/F
side view

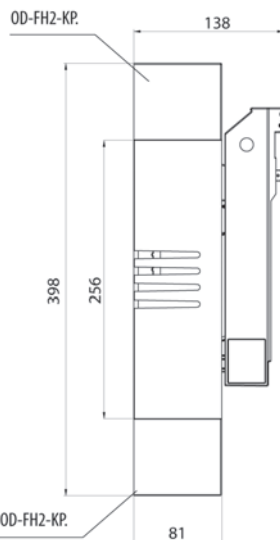

BFH2-1A/F and BFH2-3A/F
in open position

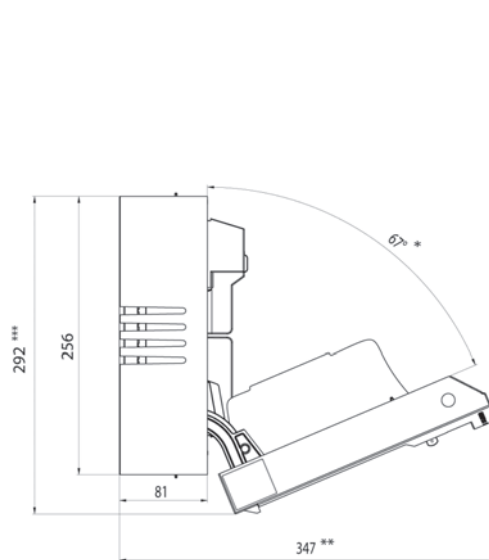

Clearance and drilling plans for
BHF2-1A/F (1 pole), for BHF2-3A/F
(3 poles) multiply the width by 3

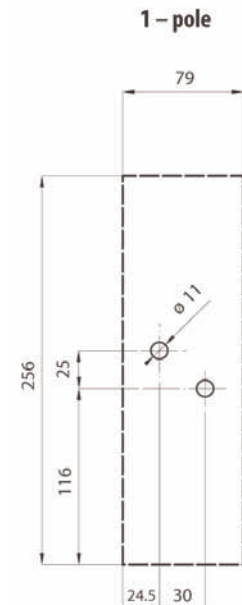

400Vac

500Vac

690Vac

aM

Accessories

NH Fuse Switch Disconnectors - Horizontal - Dimensions (mm)

Size 3

BH3-1A/F and BH3-3A/T
side view

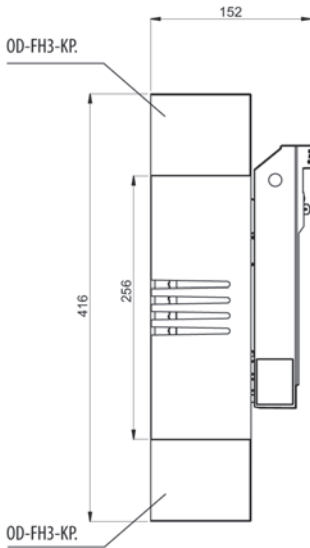

BH3-1A/F and BH3-3A/T
in open position

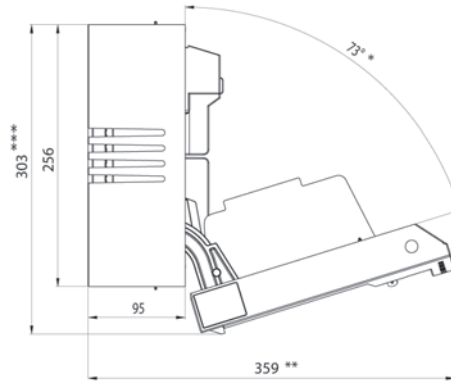

Clearance and drilling plans for
BHF3-1A/F (1 pole), for BHF3-3A/F
(3 poles) multiply the width by 3

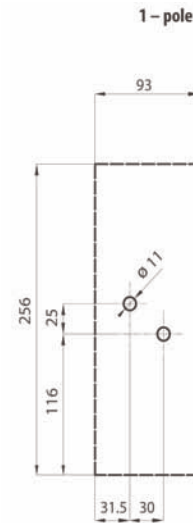

400Vac

500Vac

690Vac

aM

Accessories

Catalogue Number	Page	Catalogue Number	Page	Catalogue Number	Page	Catalogue Number	Page	Catalogue Number	Page
100NHG4G	20/27	16NHG000BI-400	12/13	315NHG03BI-400	12/17	4NHG000B	20/21	80NHG02BI	20/25
100NHG000B	20/21	16NHG01B	20/24	315NHG2B	20/25	4NHG000B-400	12/13	80NHG02BI-400	12/16
100NHG000B-400	12/13	16NHG01BI	20/24	315NHG2B-400	12/16	4NHG000B-690	30/31	80NHG0B	20/23
100NHG000BI	20/21	16NHG0B	20/23	315NHG2B-690	30/34	4NHG000BI	20/21	80NHG0B-690	30/32
100NHG000BI-400	12/13	16NHG0B-690	30/32	315NHG2BI	20/25	4NHG000BI-400	12/13	80NHG1B-690	30/33
100NHG00B-690	30/31	16NHM000B-690	38/41	315NHG2BI-400	12/16	500NHG3B	20/26	80NHG2B-690	30/34
100NHG01B	20/24	16NHM0B-690	38/41	315NHG3B-690	30/35	500NHG3B-400	12/17	80NHM00B	38/41
100NHG01B-400	12/15	200NHG02B	20/25	315NHM2B-690	38/41	500NHG3B-690	30/35	80NHM0B	38/41
100NHG01BI	20/24	200NHG02B-400	12/16	315NHM3B-690	38/41	500NHG3BI	20/26	80NHM1B	38/41
100NHG01BI-400	12/15	200NHG02BI	20/25	32NHG000B	20/21	500NHG3BI-400	12/17	BC	42
100NHG02B	20/25	200NHG02BI-400	12/16	32NHG000B-400	12/13	500NHG4G	20/27	BFD	47-48
100NHG02B-400	12/16	200NHG1B	20/24	32NHG000B-690	30/31	500NHM3B-690	38/41	BFH	49-53
100NHG02BI	20/25	200NHG1B-400	12/15	32NHG000BI	20/21	50NHG000B	20/21	BFR	45-46
100NHG02BI-400	12/16	200NHG1B-690	30/33	32NHG000BI-400	12/13	50NHG000B-400	12/13	BVL-50	42
100NHG0B	20/23	200NHG1BI	20/24	32NHG01B	20/24	50NHG000BI	20/21	CS	42
100NHG0B-690	30/32	200NHG1BI-400	12/15	32NHG01BI	20/24	50NHG000BI-400	12/13	FC	42
100NHG1B-690	30/33	200NHG2B-690	30/34	32NHG0B	20/23	50NHG00B-690	30/31	FEH	42
100NHG2B-690	30/34	200NHM1B	38/41	32NHG0B-690	30/32	50NHG01B	20/24	FPK	42
100NHM00B	38/41	200NHM2B-690	38/41	32NHM000B-690	38/41	50NHG01B-400	12/15	SB*-D	42-44
100NHM0B	38/41	20NHG000B	20/21	32NHM0B	38/41	50NHG01BI	20/24	SB*-S	42-44
100NHM1B	38/41	20NHG000B-400	12/13	355NHG03B	20/26	50NHG01BI-400	12/15	SL	42
10NHG000B	20/21	20NHG000B-690	30/31	355NHG03B-400	12/17	50NHG02B	20/25	SP	42
10NHG000B-400	12/13	20NHG000BI	20/21	355NHG03BI-400	20/26	50NHG02B-400	12/16	TB*-D	42-44
10NHG000B-690	30/31	20NHG000BI-400	12/13	355NHG03BI-400	12/17	50NHG02BI	20/25	TB00-D-IP20	42
10NHG000BI	20/21	20NHG01B	20/24	355NHG2B	20/25	50NHG02BI-400	12/16	TB00-D-IP20	42
10NHG000BI-400	12/13	20NHG01BI	20/24	355NHG2B-400	12/16	50NHG0B	20/23		
10NHG01B	20/24	20NHG0B	20/23	355NHG2BI	20/25	50NHG0B-690	30/32		
10NHG01BI	20/24	20NHG0B-690	30/32	355NHG2BI-400	12/16	50NHG1B-690	30/33		
10NHG0B	20/23	20NHM000B-690	38/41	355NHG3B-690	30/35	50NHM00B	38/41		
10NHG0B-690	30/32	20NHM0B	38/41	355NHM3B-690	38/41	50NHM0B	38/41		
10NHM000B-690	38/41	224NHG02B	20/25	35NHG000B	20/21	630NHG2B-400	12/16		
10NHM0B-690	38/41	224NHG02B-400	12/16	35NHG000B-400	12/13	630NHG3B	20/26		
1250NHG4G	20/27	224NHG02BI	20/25	35NHG000B-690	30/31	630NHG3B-400	12/17		
125NHG00B	20/22	224NHG02BI-400	12/16	35NHG000BI	20/21	630NHG3BI-400	12/17		
125NHG000B-400	12/14	224NHG1B	20/24	35NHG000BI-400	12/13	630NHG4G	20/27		
125NHG000B-690	30/31	224NHG1B-400	12/15	35NHG01B	20/24	630NHM3B	38/41		
125NHG00BI	20/22	224NHG1BI	20/24	35NHG01B-400	12/15	63NHG000B	20/21		
125NHG00BI-400	12/14	224NHG1BI-400	12/15	35NHG01BI	20/24	63NHG000B-400	12/13		
125NHG01B	20/24	224NHG2B-690	30/34	35NHG01BI-400	12/15	63NHG000BI	20/21		
125NHG01B-400	12/15	224NHM2B-690	38/41	35NHG02B	20/25	63NHG000BI-400	12/13		
125NHG01BI	20/24	250NHG02B	20/25	35NHG02B-400	12/16	63NHG00B-690	30/31		
125NHG01BI-400	12/15	250NHG02B-400	12/16	35NHG02BI	20/25	63NHG01B	20/24		
125NHG02B	20/25	250NHG02BI	20/25	35NHG02BI-400	12/16	63NHG01B-400	12/15		
125NHG02B-400	12/16	250NHG02BI-400	12/16	35NHG0B	20/23	63NHG01BI	20/24		
125NHG02BI	20/25	250NHG03B	20/26	35NHG0B-690	30/32	63NHG01BI-400	12/15		
125NHG02BI-400	12/16	250NHG03B-400	12/17	35NHM000B-690	38/41	63NHG02B	20/25		
125NHG0B	20/23	250NHG03BI	20/26	400NHG03B	20/26	63NHG02B-400	12/16		
125NHG1B-690	30/33	250NHG03BI-400	12/17	400NHG03B-400	12/17	63NHG02BI	20/25		
125NHG2B-690	30/34	250NHG1B	20/24	400NHG03BI	20/26	63NHG02BI-400	12/16		
125NHM1B	38/41	250NHG1B-400	12/15	400NHG03BI-400	12/17	63NHG0B	20/23		
125NHM2B-690	38/41	250NHG1BI	20/24	400NHG2B	20/25	63NHG0B-690	30/32		
160NHG00B	20/22	250NHG1BI-400	12/15	400NHG2B-400	12/16	63NHG1B-690	30/33		
160NHG00B-400	12/14	250NHG2B-690	30/34	400NHG2BI	20/25	63NHG2B-690	30/34		
160NHG00BI	20/22	250NHG3B-690	30/35	400NHG2BI-400	12/16	63NHM00B	38/41		
160NHG00BI-400	12/14	250NHM1B	38/41	400NHG3B-690	30/35	63NHM0B	38/41		
160NHG01B	20/24	250NHM2B-690	38/41	400NHM2B	38/41	63NHM1B	38/41		
160NHG01B-400	12/15	25NHG000B	20/21	400NHM3B-690	38/41	6NHG000B-400	12/13		
160NHG01BI	20/24	25NHG000B-400	12/13	40NHG000B	20/21	6NHG000B-690	30/31		
160NHG01BI-400	12/15	25NHG000B-690	30/31	40NHG000B-400	12/13	6NHG000BI-400	12/13		
160NHG02B	20/25	25NHG000BI	20/21	40NHG000B-690	30/31	6NHG0B-690	30/32		
160NHG02B-400	12/16	25NHG000BI-400	12/13	40NHG000BI	20/21	6NHM000B-690	38/41		
160NHG02BI	20/25	25NHG01B	20/24	40NHG000BI-400	12/13	6NHM0B-690	38/41		
160NHG02BI-400	12/16	25NHG01BI	20/24	40NHG01B	20/24	800NHG4G	20/27		
160NHG0B	20/23	25NHG0B	20/23	40NHG01B-400	12/15	80NHG000B	20/21		
160NHG1B-690	30/33	25NHG0B-690	30/32	40NHG01BI	20/24	80NHG000B-400	12/13		
160NHG2B-690	30/34	25NHM000B-690	38/41	40NHG01BI-400	12/15	80NHG000BI	20/21		
160NHM00B	38/41	2NHG000B	20/21	40NHG02B	20/25	80NHG000BI-400	12/13		
160NHM1B	38/41	2NHG000B-400	12/13	40NHG02B-400	12/16	80NHG00B-690	30/31		
160NHM1B-690	38/41	2NHG000B-690	30/31	40NHG02BI	20/25	80NHG01B	20/24		
160NHM2B-690	38/41	2NHG000BI	20/21	40NHG02BI-400	12/16	80NHG01B-400	12/15		
16NHG000B	20/21	2NHG000BI-400	12/13	40NHG0B	20/23	80NHG01BI	20/24		
16NHG000B-400	12/13	315NHG03B	20/26	40NHG0B-690	30/32	80NHG01BI-400	12/15		
16NHG000B-690	30/31	315NHG03B-400	12/17	40NHM000B-690	38/41	80NHG02B	20/25		
16NHG000BI	20/21	315NHG03BI	20/26	425NHG3B-690	30/35	80NHG02B-400	12/16		

Cooper Bussmann® Products and Technical Expertise Delivered Worldwide

Customer Assistance

Customer Satisfaction Team

The Cooper Bussmann Customer Satisfaction Team is available to answer questions regarding Cooper Bussmann products.

Calls can be made between:

Monday-Thursday 7.30 a.m. - 5.30 p.m. GMT
Friday 7.30 a.m. - 5.00 p.m. GMT

The Customer Satisfaction Team can be reached via:

- Phone: 00 44 (0) 1509 882 600
- Fax: 00 44 (0) 1509 882 786
- E-mail: bulesales@cooperindustries.com

Application Engineering

Application Engineering assistance is available to all customers. The Application Engineering team is staffed by university-qualified electrical engineers who are available by phone with technical and application support.

Monday – Thursday 8.30 a.m. – 4.30 p.m. GMT
Friday 8.30 a.m. - 4.00 p.m. GMT

Application Engineering can be reached via phone, fax or email:

- Phone: 00 44 (0) 1509 882 699
- Fax: 00 44 (0) 1509 882 794
- E-mail: buletechnical@cooperindustries.com

Online Resources

Visit www.cooperbussmann.com for the following resources:

- Product cross reference
- Product data sheets
- Product profiles
- Online catalogues featuring the latest United States and European products

Your Authorised Distributor: